

# TECHNICAL GUIDE BOOK

# FLOWSOR



<b>Chapter 1</b>	INTRODUCTION TO FLOW METERS	P. 4
.....		
<b>Chapter 2</b>	FLOW METER TYPES & PRINCIPLES	P. 6
.....		
<b>Chapter 3</b>	SOURCES OF TROUBLE FOR FLOW METERS	P. 14
.....		
<b>Chapter 4</b>	PRESSURE LOSS	P. 16
.....		
<b>Chapter 5</b>	PIPING TECHNIQUES	P. 18

**1. INTRODUCTION**

The role of a flow meter is to perform a measurement that answers questions like, how many gallons of flow do we have currently or how many gallons have we used so far? Flow meters are actually used in a wide variety of areas. For example, flow meters play a vital role in situations such as stopping the supply of fuel once you have 10 gallons of gasoline, or administering only 500 cc of medicine to a hospital patient. The primary role of flow meters in the Factory Automation field is to manage the flow of "water". The use of this "water" varies according to the application and it is sometimes referred to as "coolant", "cooling water", "cutting water", or "grinding water". In addition, recent energy conservation laws and traceability requirements have expanded the general need for flow meters.

**2. COOLING WATER**

As mentioned above, "cooling water" is one of the most frequently used applications of water in Factory Automation. Additionally, due to its role in the prevention of overheating during processing, "cutting water", often referred to as coolant, can be broadly classified as "cooling water" as well. Opposite to cooling, water may also be used as "insulating water".

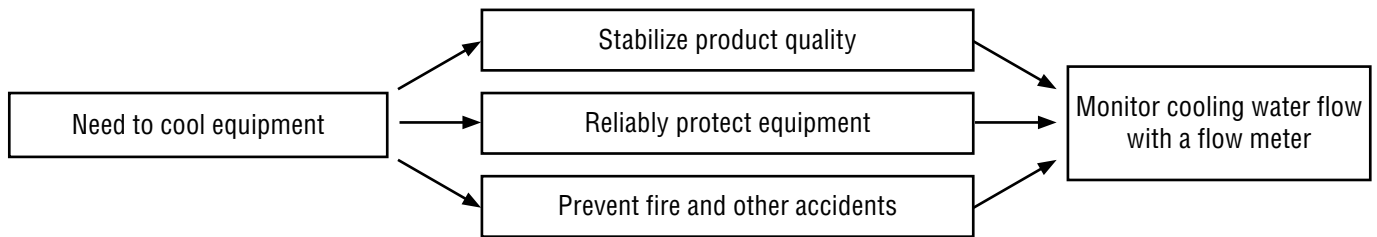

Tap water is not generally used because "cooling water" is not for human consumption. Instead, industrial water is pumped from groundwater or directly from rivers. Because all water is viewed as a limited and vital resource, it is generally circulated repeatedly prior to being cleaned and discharged.

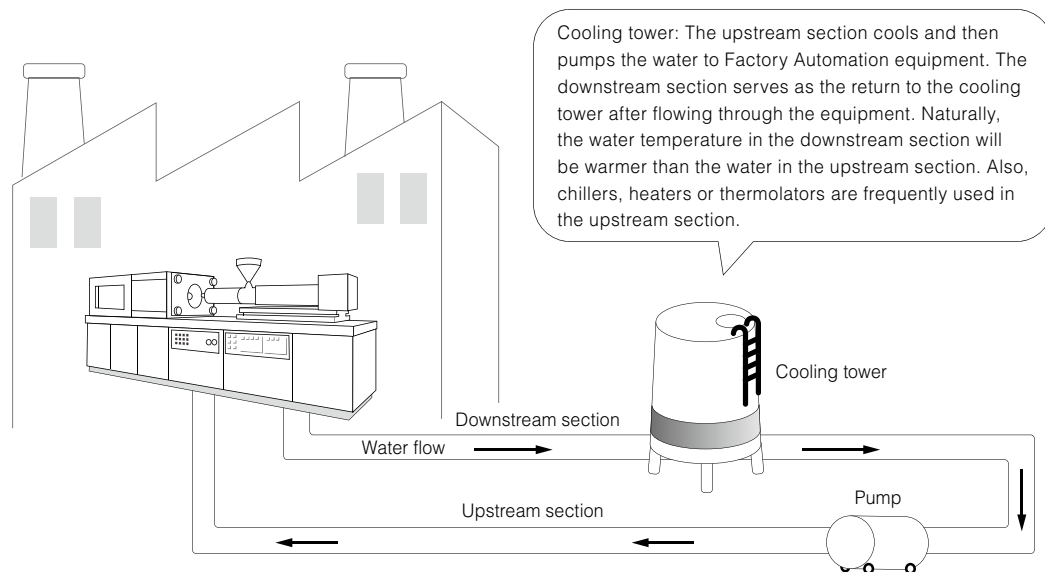

### 3. INSTANTANEOUS FLOW & INTEGRATED FLOW

Flow control in Factory Automation generally falls into one of two types of flow measurement.

#### (1) Instantaneous flow

"Instantaneous flow" specifies the volume of flow per fixed amount of time. For example, instantaneous flow is equal to 10 gal/min when using 10 gallons of flow in the span of 1 minute.

Ex.) A vacuum pump must be supplied with 10 gallons of cooling water every minute.

#### (2) Integrated flow

"Integrated flow" specifies the cumulative value of flow used from the start to finish of measurement. For example, when water has accumulated in a tank for an hour at an instantaneous flow of 100 gal/min, the integrated flow is equal to 6000 gallons.

Ex.) How much coolant does this grinding machine use in 1 day?

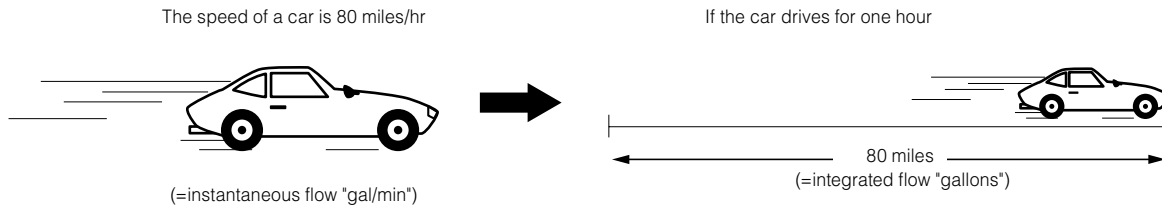

The speedometer of the car is instant (instantaneous), and the trip meter and odometer is cumulative (integrated).

### 4. FLOW METER DISPLAYS

Newer flow meters sometimes include built-in indicators. This is because it is extremely difficult to make accurate settings without a numerical display. Flow within piping can be determined by physical elements such as pipe diameter, the pressure that creates the liquid flow, and the viscosity of the liquid. However, if actually questioned as to how much flow is in the pipe, there is no simple way to know the precise amount. Even if attempting to issue a precise low limit alarm using a flow meter without an indicator, "gauging" must be performed using the procedures below.

**MEASURE  
NORMAL FLOW**

1. Install a flow meter and valve.
2. Ensure normal flow and begin running the water.
3. Try to accumulate the flowing water for a fixed period of time.
4. Find instantaneous flow from the weight or volume of the accumulated water.

**PERFORM ALARM  
SETTINGS**

1. Run the water and tighten the valve. Then create a pseudo lower limit alarm level.
2. Measure the water after accumulating it in a container. Then confirm if you have found the instantaneous flow of the lower limit alarm.
3. Once done, perform settings for the flow meter so that it will emit real signals.

1. ELECTROMAGNETIC FLOW METERS

PRINCIPLES

Electromagnetic flow meters detect flow by using Faraday's Law of induction.

Under Faraday's law of induction, moving conductive liquids inside of a magnetic field generates an electromotive force (voltage) in which the pipe inner diameter, magnetic field strength, and average flow velocity are all proportional. In other words, the flow velocity of liquid moving in a magnetic field is converted into electricity. (E is proportional to  $V \times B \times D$ )

Inside an electromagnetic flow meter, there is an electromagnetic coil that generates a magnetic field, and electrodes that capture electromotive force (voltage). Due to this, although it may appear as if there is nothing inside the flow pipe of an electromagnetic flow meter, flow can be measured.

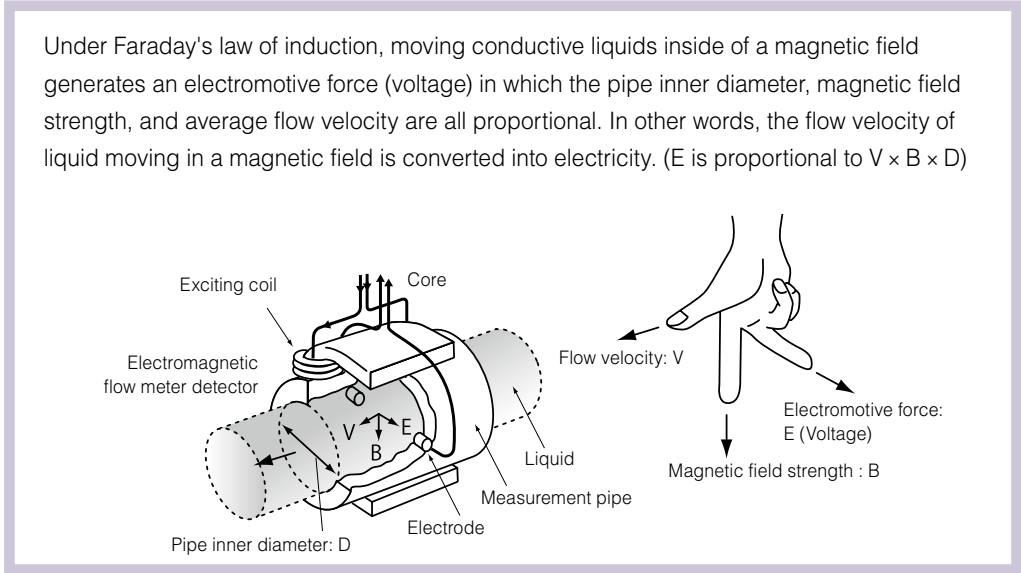

As the flow changes, the electromotive force (voltage) captured by the electrodes changes as follows.

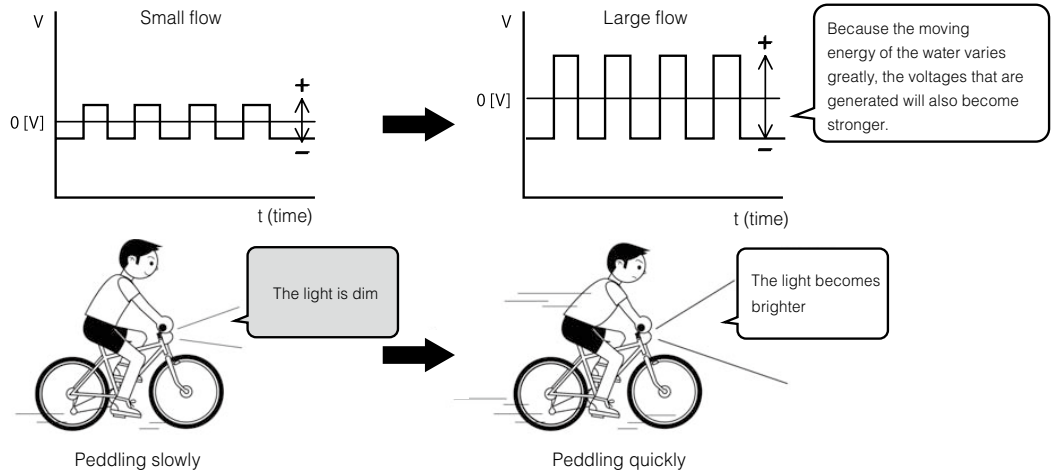

FEATURES OF AN ELECTROMAGNETIC FLOW METER

Within the context of the principles listed above, electromagnetic flow meters generally have the following features.

PROS	<ul style="list-style-type: none"> <li>• Unaffected by the temperature, pressure, density, or viscosity of the liquid</li> <li>• Able to detect liquids that include contaminants (solids, air bubbles)</li> <li>• There is no pressure loss</li> <li>• No moving parts (improves reliability)</li> </ul>	CONS	<ul style="list-style-type: none"> <li>• Cannot detect gases and liquids without electrical conductivity</li> <li>• A short section of straight pipe is required</li> </ul>
------	---	------	---

## FLOW METER TYPES &amp; PRINCIPLES

## ELECTRICAL CONDUCTIVITY

There is one important point when using electromagnetic flow meters. Because electromagnetic flow meters are based on the laws of electromagnetic induction, conductive liquids are the only liquids for which flow can be detected. Whether it is a conductive liquid or not is determined by the presence of electrical conductivity. So, just what is electrical conductivity?

Electrical conductivity generally is a value that expresses the ease for electricity to flow. The opposite numerical value is resistivity, which expresses the level of difficulty for electricity to flow. For units, S/cm (siemens per centimeter) is primarily used. To determine how easily electricity will flow, 1 cm<sup>2</sup> electrodes are placed 1 cm apart.

Using tap water at 100 to 200  $\mu$ S/cm, mineral water at 100 to 500  $\mu$ S/cm, and pure water at 0.1  $\mu$ S/cm or less as samples, we can provide examples of actual measured electrical conductivity.

In order to calculate electrical conductivity, it is necessary that conditions, such as electrode area and the distance between electrodes, are properly calculated. Because of this, it is fairly difficult to calculate. As a general way to confirm electrical conductivity, an electrical conductivity meter (US\$50-1000) can be used to perform this measurement.

## WHY DOES WATER CONDUCT ELECTRICITY?

H<sub>2</sub>O itself is a stable molecule, and will not conduct electricity.

So, why does electricity flow in water?

The secret is that the absence or presence of impurities in the water determine its ability to conduct electricity.

Besides H<sub>2</sub>O (water molecules), Ca<sub>2</sub><sup>+</sup> (Calcium ions) and Mg<sub>2</sub><sup>+</sup> (Magnesium ions) exist within water. The terms hard water and soft water are determined by the amount of ions found within a given amount of water. Because these ions conduct electricity within water, tap water, groundwater and other ion rich waters possess a property that conducts electricity. Also, since pure water is only H<sub>2</sub>O and does not contain any impurities, it cannot conduct electricity.

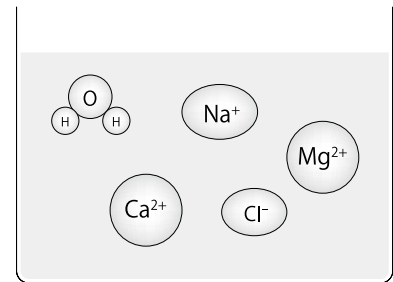

## QUICK TECHNIQUE

When you would simply like to confirm the presence or absence of electrical conductivity, a standard multi-meter can be used. Place the tester in a mode that measures resistance values and place both probes into the liquid. If the needle of the tester moves even slightly towards the zero side, it shows that electricity is flowing.\* Conversely, if the needle does not move from  $\infty$  at all, then there is no electrical conductivity. It can be judged that detection with an electromagnetic flow meter is not possible.

\*As a precautionary measure, confirmation using an electrical conductivity meter is required.

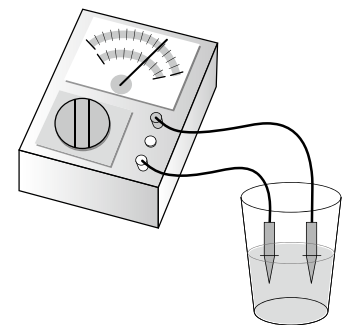

## 2. KARMAN VORTEX FLOW METER

### PRINCIPLES

Classified as a vortex flow meter, this device utilizes a law that was theoretically proven by Theodore von Karman in 1912. When there is a column-shaped obstruction (vortex shedder) in flowing fluid, it will generate alternating vortices downstream.

The flow velocity of the fluid and the vortex generation frequency are proportional to each other. Therefore, detecting the number or pulse of vortices makes it possible to measure flow. The main method of detection involves sensing the vortex vibration with a piezo element. However, a more robust method utilizes ultrasonic waves to detect the vortex vibration.

STRUCTURAL DIAGRAM OF A KARMAN VORTEX FLOW METER

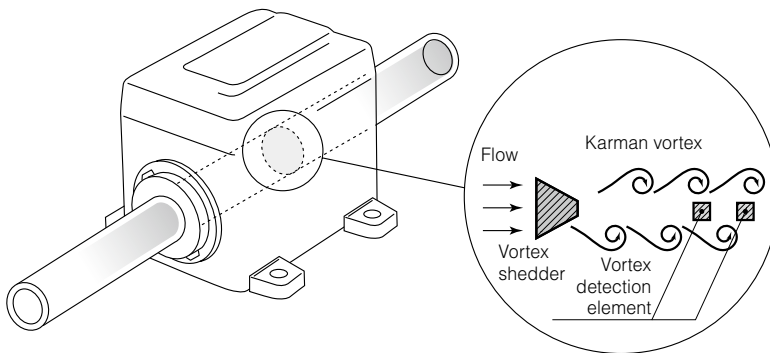

### FEATURES OF THE KARMAN VORTEX FLOW METER

#### PROS

- No mechanical moving parts
- Can detect liquids, gases, and vapors
- Because there are no electrodes, it has specifications that offer excellent chemical resistance
- Has large range ability and good accuracy

#### CONS

- Because it restricts the flow path, pressure loss will occur
- Scale deposits and liquids that include solids become the cause of "clogging"
- Not suited for high-viscosity fluids
- Sensitive to pipe vibrations
- A section of straight pipe is required



## FLOW METER TYPES &amp; PRINCIPLES

## 3. PADDLE WHEEL FLOW METER

## PRINCIPLES

This is classified as a turbine flow meter. Paddle wheel flow meters are generally divided into two mechanical classes as described below:

- (1) Tangential-flow paddle wheel flow meters, with a water wheel structure
- (2) Axis-flow paddle wheel flow meters, with a windmill structure

The flow and the revolutions of the paddle wheel are proportional to each other. Thus, by spinning the paddle wheel with the force from the flowing fluid, it becomes possible to measure the rate of this flow from the number of revolutions. By embedding a magnet in the rotation axis and on the edge of the paddle, pulses can be extracted as signals, converting the number of revolutions into the flow rate.

## FLOW CALCULATION METHODS

$$\text{Flow per single pulse} \times \text{amount of pulses} \div \text{time} = \text{instantaneous flow}$$

## STRUCTURAL DIAGRAM OF A PADDLE WHEEL FLOW METER

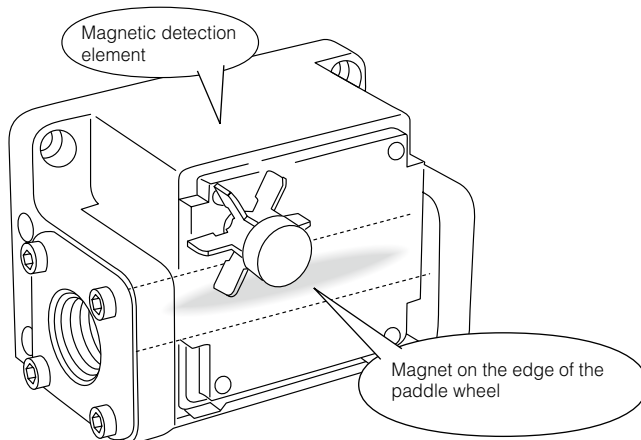

## FEATURES OF A PADDLE WHEEL FLOW METER

- |      |  |
|------|--|
| PROS | <ul style="list-style-type: none"> <li>• Excellent reproducibility and responsiveness</li> <li>• A simple structure with a low price</li> <li>• Compact and can perform large-capacity measurement</li> </ul>  |
| CONS | <ul style="list-style-type: none"> <li>• Extremely sensitive to foreign objects (Causes clogging)</li> <li>• Because the paddle wheel spins at high-speeds, periodic maintenance is needed to deal with axial wear or the paddle wheel must be replaced</li> </ul> |

### 4. FLOATING ELEMENT FLOW METER

#### PRINCIPLES

This is classified as an area flow meter. Its mainstream method involves suspending a float in a tapered pipe (a pipe that progressively widens heading upwards). When the fluid is forced in between the tapered pipe and the float, a differential pressure is generated. When this happens, the float stops at an area where the upward force caused by differential pressure and the downward force caused by the weight of the float have been equalized. The resulting display is the instantaneous flow.

Commonly, the tapered pipe is manufactured from transparent materials calibrated for flow and measurements are read directly from the pipe. There are also types available that have a magnet built into the float and perform detection using a magnetic sensor.

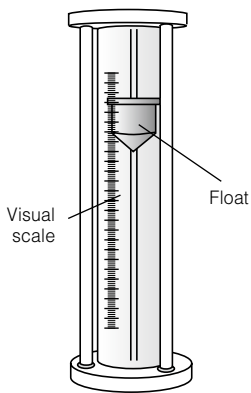

#### FEATURES OF A FLOATING ELEMENT FLOW METER

**PROS**

- Able to detect gases, liquids, and vapors
- Generally low priced
- Comparatively low pressure loss

**CONS**

- Does not offer very high accuracy
- Not suited for fluids that include solids (clogging will occur)
- With the directly-read type, the float cannot be seen if the tapered pipe becomes dirty (frequent maintenance required)

### 5. THERMAL FLOW METERS

#### PRINCIPLES

When fluid comes into contact with a heated object, the fluid takes heat away from the object, increasing the temperature of the fluid. A thermal flow meter uses this principle to measure flow. Thermal flow meters can be divided into two groups:

#### (1) The temperature difference measurement method

A heater is installed in the fluid, and fluid temperature is measured at 2 points, upstream and downstream. Then flow is determined by the temperature difference between these 2 points. This is primarily used for applications with low flow rates.

#### (2) The power consumption measurement method

A heater is installed in the fluid and fluid temperature is measured at 2 points, upstream and downstream. The heater is controlled to constantly maintain a fixed temperature difference between these 2 points. Flow is determined based on the amount of power required to maintain this temperature.

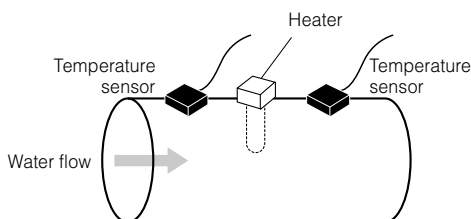

#### FEATURES OF A THERMAL FLOW METER

**PROS**

- Able to detect gases
- There is basically no pressure loss
- Can measure mass flow

**CONS**

- Errors occur when the temperature of the fluid changes
- It is difficult to set-up specifications that match the type and composition of the fluid
- Errors occur when there are deposits/buildup on the temperature sensors or heating element

# FLOW METER TYPES & PRINCIPLES

## 6. PRESSURE DIAPHRAGM FLOW METERS

### PRINCIPLES

This is classified as a differential pressure flow meter. Differential pressure flow meters currently have the top market share for flow meter production volume. Using Bernoulli's principle, an orifice plate is installed into the path of flowing fluid, deliberately causing pressure loss. The pressure differential before and after the orifice plate is measured. The relationship between the pressure loss generated by the orifice plate, the flow velocity, and the flow rate are as follows:

Small flow ► small flow velocity ► The pressure loss created by the orifice plate is small  
 Large flow ► large flow velocity ► The pressure loss created by the orifice plate is large

The difference in pressure between upstream and downstream is detected using a pressure diaphragm.

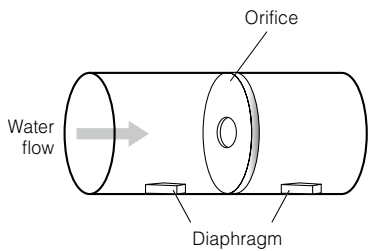

### FEATURES OF A DIAPHRAGM FLOW METER

<b>PROS</b>	<ul style="list-style-type: none"> <li>• Able to detect gases, liquids, and vapors</li> <li>• Generally low priced</li> <li>• No moving parts</li> </ul>
<b>CONS</b>	<ul style="list-style-type: none"> <li>• Because there is an orifice plate, great pressure loss occurs</li> <li>• Not suited for fluids that include solids (clogging occurs)</li> <li>• Because it is sensitive to turbulent flow, a long section of straight pipe is required</li> </ul>

## 7. ULTRASONIC FLOW METERS

### PRINCIPLES

An additional type of flow meter technology uses an ultrasonic sensor. The most popular form of this utilizes the principle known as either transit time or time of flight.

#### [Transit time flow meters]

Sensors transmit and receive ultrasonic waves that are sent diagonally through the fluid in the pipe. The ultrasonic waves are accelerated as the flow rate increases. In turn, the ultrasonic waves are decelerated as the flow rate decreases. The difference in the transmission time of the ultrasonic waves is measured as a flow rate.

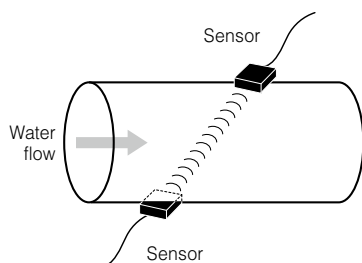

### FEATURES OF AN ULTRASONIC FLOW METER

<b>PROS</b>	<ul style="list-style-type: none"> <li>• There is no pressure loss</li> <li>• A type that can perform detection from the outside of piping is available</li> </ul>
<b>CONS</b>	<ul style="list-style-type: none"> <li>• A long section of straight pipe is required</li> <li>• Liquids that have a large solid content will cause malfunctions</li> <li>• Measurement is not possible when there are many air bubbles</li> </ul>

8. CORIOLIS FLOW METERS

PRINCIPLES

Coriolis flow meters are flow meters that use a physical phenomenon called the Coriolis effect inside the flow meter itself. As seen in the illustration below, when fluid flows through a vibrating U-shaped pipe, the Coriolis effect goes into action, reversing the flow between the entrance-side, A, and the exit-side, B, and twisting the pipe. With the Coriolis effect, the weight and speed of an object are proportional to each other, so the amount of twist is measured and mass flow is understood.

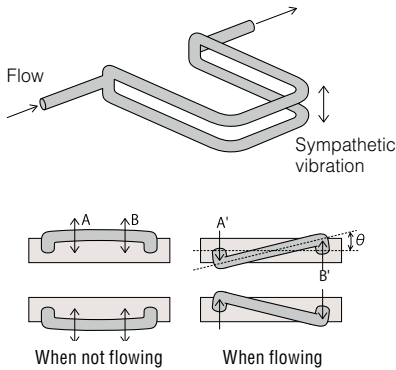

FEATURES OF A CORIOLIS FLOW METER

<b>PROS</b>	<ul style="list-style-type: none"> <li>• High-accuracy</li> <li>• Can measure mass flow</li> <li>• A section of straight pipe is not required</li> </ul>	<ul style="list-style-type: none"> <li>• High-speed response</li> <li>• Able to detect high-viscosity liquids</li> <li>• Can measure density</li> </ul>
<b>CONS</b>	<ul style="list-style-type: none"> <li>• High-priced compared to other detection principles</li> <li>• Pressure loss is large</li> <li>• Easily affected by vibration</li> </ul>	

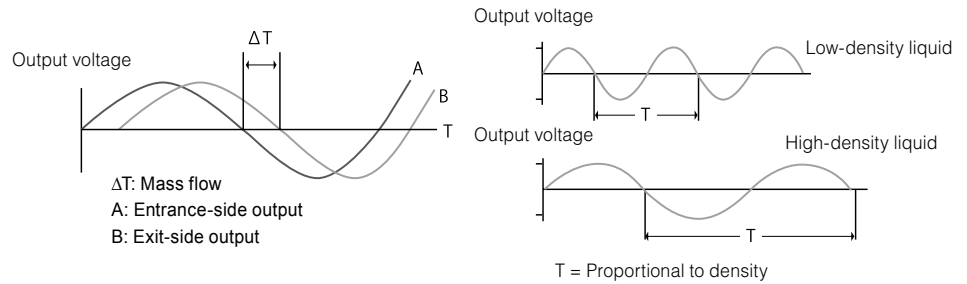

WHAT IS THE CORIOLIS EFFECT?

In the northern hemisphere, a bullet that is shot directly north from the equator will veer slightly east (right) of the target. This is because the earth rotates from west to east and the moving speed of an object from a resting state at the equator is fast, so the effect of inertia goes into action at the target point.

In a similar manner, if the amplitude at the midpoint of the U-shaped tubes is increased to create large vibrations, once fluid flows through the inside of the tubes, a Coriolis effect in which the mass and speed of the flow (mass flow) is proportional to each other, goes into action.

The effect works in opposite directions for the entrance and exit sides, twisting the pipes. By comparing the pipe entrance and exit side output voltage signals, performing a calculation, and then measuring the amount of twist, mass flow is understood.

# FLOW METER TYPES & PRINCIPLES

## HOW TO SELECT A FLOW METER

When selecting a flow meter, follow the steps below:

- 1 Confirm the properties of the detection fluid
- 2 Confirm the purpose of measurement and determine the detection method
- 3 Confirm product specifications
- 4 Consider cost

1 First, it is necessary to confirm the properties of detection fluids.

Fluid types	Gas, Liquid, Vapor, etc.
Density	Can be calculated from fluid name, temperature and pressure
Viscosity	Required for liquids
Electrical conductivity	Required for electromagnetic type flow meters
Contaminants	Air bubbles, mixed-in foreign objects, slurry, etc.
Flow range	Minimum and maximum flow
Fluid temperature	Measured in response to the fluid
Fluid pressure	For pressure-resistance confirmation
Pressure loss	Measured as necessary

- 2 Next, clarify the purpose of measurement. At this point, determine a selectable detection system along with properties such as accuracy and flow range.
- 3 Once the detection method has been determined, make a decision while confirming detailed model specifications.
- 4 Finally, compare costs. Because removing a flow meter also takes time, you must make a decision that not only considers the unit price of the product, but also considers maintenance time after installation as well as the cost of set-up or troubleshooting. Generally when the product unit price is low, frequent maintenance or failure replacement may be required.

### COMPARISON OF EACH FLOW METER DETECTION METHOD [REPRESENTATIVE EXAMPLE]

	Electromagnetic type	Karman vortex type	Paddle wheel type	Floating element type	Thermal type	Diaphragm type	Ultrasonic type	Coriolis type
Liquid	Available	Available	Available	Available	N/A	Available	Available	Available
Gas	N/A	Available	N/A	Available	Available	Available	Available	Conditional
Vapor	N/A	Available	N/A	Available	N/A	Available	Conditional	N/A
High temperature support	Available	Available	Available	Available	Available	Available	Available	Available
Micro flow	Conditional	N/A	Available	N/A	Available	Conditional	N/A	Available
Medium flow	Available	Available	Conditional	Available	Available	Available	Conditional	Available
Large flow	Available	Available	Conditional	Available	Available	Available	Available	Conditional
Viscosity	Available	N/A	N/A	Conditional	N/A	N/A	Available	Conditional
Slurry	Available	Conditional	N/A	Conditional	N/A	Available	Available	Available
Oil	N/A	N/A	Available	Available	N/A	Available	Available	Available
Accuracy	Available	Available	Conditional	Conditional	Available	N/A	Available	Available
Maintainability	Available	Available	N/A	N/A	N/A	N/A	Available	Available
Pressure loss	Available	Conditional	N/A	Conditional	N/A	N/A	Available	N/A
Air bubbles	Conditional	Conditional	Conditional	Conditional	N/A	N/A	N/A	Available

# SOURCES OF TROUBLE FOR FLOW METERS

## COMMON PROBLEMS RELATED TO FLOW SENSORS

(Representative examples)

### 1. SCALING

This describes objects created by metallic ions contained in groundwater or tap water that have crystallized and attached to the inner-walls of the piping. They are composed of elements such as calcium, magnesium, and sodium. If buildup of too many layers occurs, the flow path inside the piping narrows and restricts flow. There is also the possibility that scaling will attach to the inside of the flow meter and negatively affect its operation. Additionally, for flow meters with mechanical components, it is possible that fragments will break off from this buildup and result in clogging.

When using floating element and paddle wheel flow meters, the display may no longer be readable or the moving mechanisms may clog. There are almost no problems with electromagnetic types, but if a thick layer of scaling attaches to the inside of the flow path, eventually the flow meter could become unable to sense the voltage that has been generated and maintenance would be required.

### 2. SLUDGE

This is a generic term for foreign objects that exist within the fluid such as suspended matter and sediment. On a production line, this generally includes chips and abrasive grain coming from a grinding machine. Sludge is constantly circulated along with the fluid and causes clogging of the flow meter or acts as noise interference. With a flow meter that has mechanical components in the piping, axial wear and abrasion may occur, and flow may be lowered. Though sludge can be removed using a strainer\* or magnetic separator, complete removal is difficult and maintenance is still required.

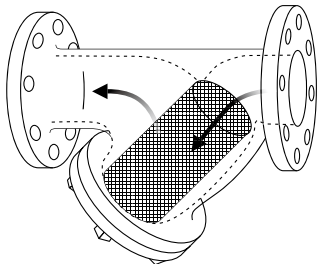

**\*STRAINER**  
A filter for the purpose of removing large foreign particles (sludge) in the fluid. As seen in the illustration below, the fluid is filtered through a metallic mesh. The filter can be removed and cleaned.

With an electromagnetic type flow meter, the flow pipe has a free-flowing structure, so accumulation and clogging does not occur. Sludge colliding with the "wetted" electrodes can create interference. However, the effects can be limited by utilizing an electromagnetic flow sensor with "non-wetted" electrodes. Also, flow sensors that can adjust the response time and sampling frequency are less vulnerable.

### 3. RUST

Different from scaling, this is when oxidation occurs within the pipes. Corrosion-inhibitors can be added to the fluid to prevent rust, but if pipes that are not in use come into contact with air, rust will occur. Once water flows through the pipes again, the rust turns into fragments, which flake off and become the cause of clogging inside the flow meter or attach to the window sections of floating element flow meters.

Rust creates the same basic concerns that were listed for "sludge".

### 4. SLIME

This involves living matter such as algae and microorganisms in the water. It is sticky, and mud-like. Similar to scaling, clogging and obstructions will occur in paddle-wheel types, along with limiting the visible portion of the floating element type meters.

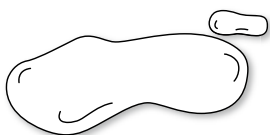

With an electromagnetic type flow meter, the flow pipe has a free-flowing structure, so accumulation and clogging does not occur. Also, because the slime itself possesses electrical conductivity, detection remains possible.

## SOURCES OF TROUBLE FOR FLOW METERS

## 5. SLURRY

Slurry is a generic term for liquids that contain a uniform amount of solid particles throughout. This includes liquids that contain abrasives. The individual particles may wear down the inside of a flow meter or coagulate and cause clogging.

For flow meters that obstruct flow (i.e. Karman vortex models), the slurry may cause axial wear and clogging. With an electromagnetic type flow meter, wear and clogging are minimal due to the free-flowing structure of the unit. Slurry detection is also possible using Coriolis type flow meters.

## 6. AIR BUBBLES

When dealing with an open system, it is possible for air to be introduced into the system during liquid intake. Air or impurities that have blended into the liquid cause bubbles. For a vortex flow meter, these bubbles disturb the creation of Karman vortices. For an ultrasonic flow meter, they inhibit the propagation of ultrasonic waves. Both cases result in malfunctions.

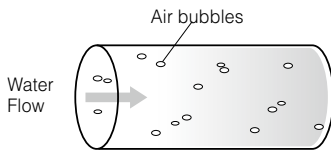

Since Coriolis type flow meters measure mass flow, they are unaffected by air bubbles. For electromagnetic type flow meters, bubbles can cause unstable flow readings. This is due to the fact that detection is based on volume and the bubbles are mistaken for fluid.

## 7. IRREGULARITY OR DEVIATION IN FLOWS

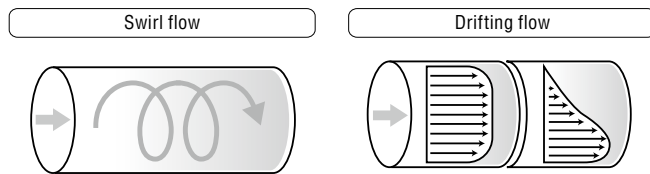

The degree of measurement error depends on the degree of irregularity in the distribution of flow velocity. Measurement performance can be improved by installing straight pipe sections upstream to make the distribution of flow velocity more uniform. (As a rough guide, the straight pipe section should be 5 times the bore diameter of the flow path.)

The distribution of flow velocity within circular piping is uniform after the flow has passed through a sufficient amount of straight pipe. On the other hand, the distribution of flow velocity becomes irregular due to bends in the piping or changes in the pipe diameter. Drifting occurs when the center of the distribution of flow velocity shifts away from the center of the pipe. Swirl flow occurs when the fluid rotates around a center axis, parallel to the direction of flow. Both swirling and drifting cause irregular distributions of flow velocity. Performing flow measurements in these conditions may lead to large measurement errors.

## 8. PULSATING FLOW

If the pulsations are large, the instantaneous flow may temporarily exceed the rated flow range of the flow meter. In this situation, the flow displayed on the flow meter is smaller than the actual flow. Volume type reciprocating pumps are known for generating large pulsations.

One possible way to reduce pulsations is by using a damper such as an accumulator. Also, if the pulsations cause fluctuations in the numeric values of the flow meter over time, increasing the flow meter's response time is effective at stabilizing the numeric values.

## 9. PIPING VIBRATION

Piping vibration is commonly caused by machine vibration, opening and closing of valves, and even the transmission of the fluid itself.

With Coriolis and Karman vortex type flow meters, the flow may not be properly measured due to vibration. With electromagnetic and ultrasonic type flow meters, there are essentially no problems caused by vibration. (With ultrasonic type flow meters, there is such a large difference between the frequencies of the ultrasonic waves, piping vibrations can be ignored.)

## 1. WHAT IS PRESSURE LOSS?

As an example, if part of the flow path is restricted, the downstream pressure will reduce starting from the restricted area. This is called pressure loss. Pressure loss is energy loss and not only is downstream pressure lowered, but flow, and flow velocity are reduced as well.

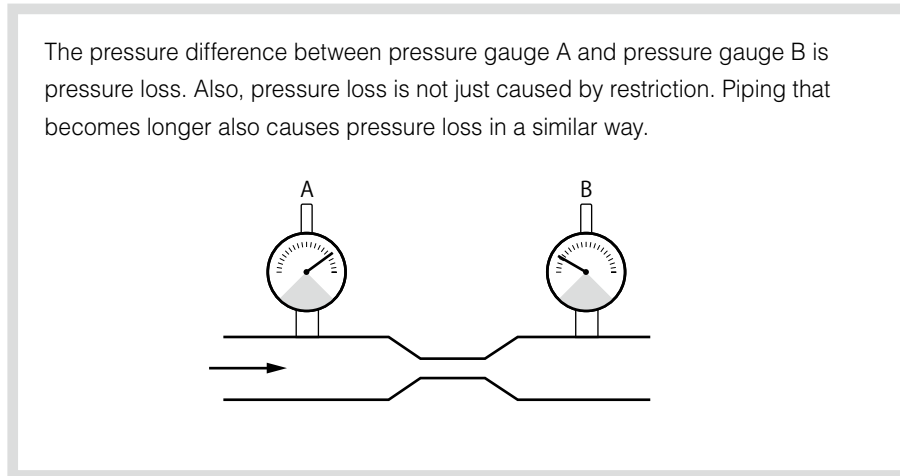

When pressure loss occurs on a production line, the flow of circulating cooling water is lowered, causing a variety of quality and production problems. To correct this, it is best to remove the part that is creating the pressure loss. However, in most cases pressure loss is reactively handled by raising the pressure generated by the circulation pump and/or raising the power of the pump itself. This measure results in a waste of energy and unnecessary cost.

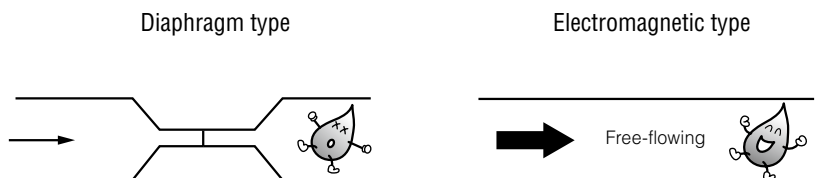



## 2. FACTORS THAT CAUSE “PRESSURE LOSS”

### [1] NARROWING THE PIPE DIAMETER

Restricting the flow path means that piping joints with different diameters will result in pressure loss.

### [2] BENDING THE PIPING

Liquid flows straight according to the law of inertia. Due to this, the liquid experiences a loss of energy when encountering a bend in the pipe. This energy loss correlates to a decrease in pressure.

### [3] INSTALLING AN OPEN/CLOSE VALVE

If ball valves and other such valves are left fully opened, then pressure loss should not be a concern. However, with valves that change the flow path inside the valve, pressure loss will occur even if fully opened.

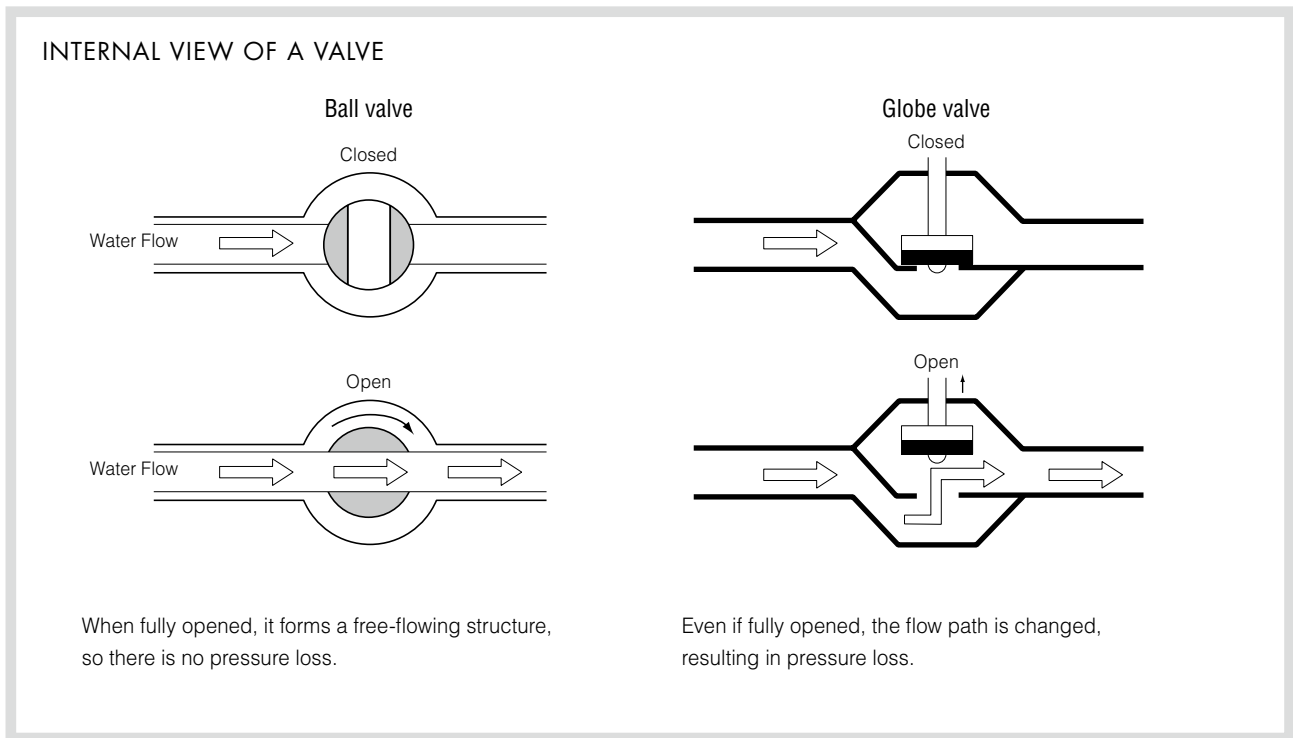

### [4] INSTALLING A FLOW METER

As stated in the operating principles, differential pressure flow meters (diaphragm types) create pressure loss from flow restricting plates to measure flow. Additionally, Karman vortex flow meters restrict and accelerate the flow path in order to provide stable vibrations for the piezo element. Also, with paddle wheel flow meters, the flow path is restricted in order to generate enough thrust to spin the paddles when there is small flow. For these types of flow meters, pressure loss occurs easily. Conversely, with electromagnetic, non-insertion thermal, and ultrasonic flow meters, there is no need to restrict the flow path for detection, which stands as a sizeable advantage in regard to pressure loss.

# PIPING TECHNIQUES

In order to use a flow sensor under the most reliable conditions, it is necessary to consider the piping and position of the flow meter installation. Though not absolutely necessary, these suggestions should be followed in order to best stabilize flow measurement.

## 1. SUFFICIENTLY INSTALL STRAIGHT PIPE SECTIONS

Creates a laminar flow state  
 $L = 5D$  or more

L represents the length of a straight pipe section and D represents the nominal bore diameter of the flow meter unit.

90° bent pipe

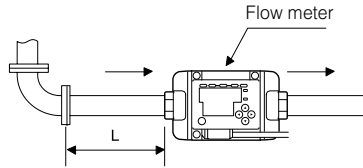

Expanding pipe

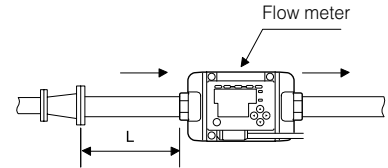

T-pipe

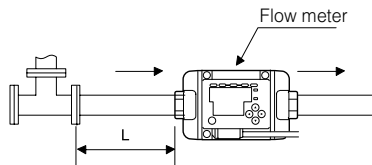

Fully opened gate valve

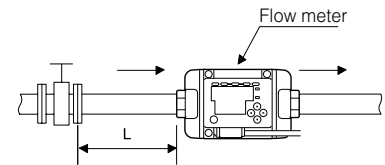

Be sure to install a straight pipe section equivalent to 5 times the bore diameter upstream from the flow meter. This section limits turbulence in the liquid and creates uniform flow. \* Regarding the irregular distribution of flow velocity, refer to Chapter 3, Section 7.

## 2. MAKE THE FLUID FLOW FROM LOWER TO UPPER SECTIONS

Creates a full volume state

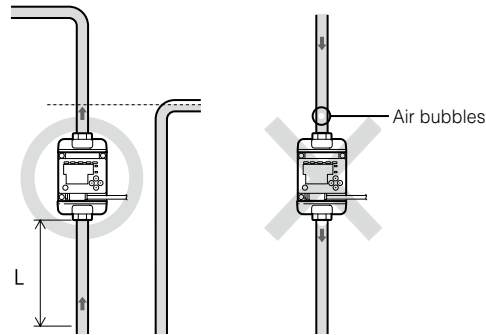

Flow sensors best measure flow when the flow path is in a full volume state. Water accumulates in lower sections due to gravity. When water flows in piping like the illustrations above and below, a full volume state is maintained.

## 3. INSTALL IN LOWER SECTIONS OF PIPING

Creates a full volume state

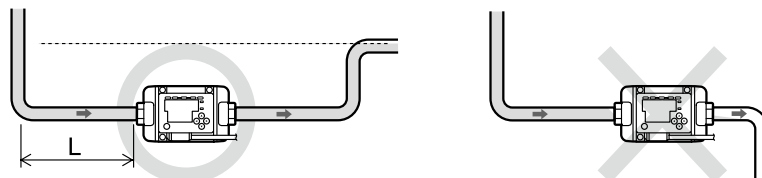

**4. INSTALL IN LOWER SECTIONS OF PIPING**

Prevents air bubbles from mixing into the fluid

Air bubbles collect in the upper sections of water. When the piping is bent as in the top illustration, it is possible to prevent bubbles from mixing into the fluid.

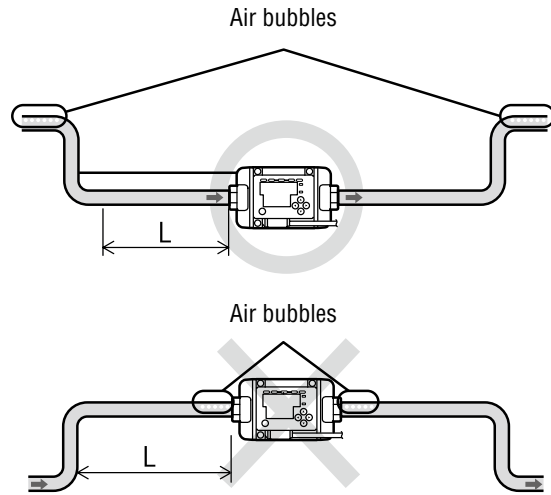

**4. INSTALL A BYPASS LINE**

Improves maintenance ability

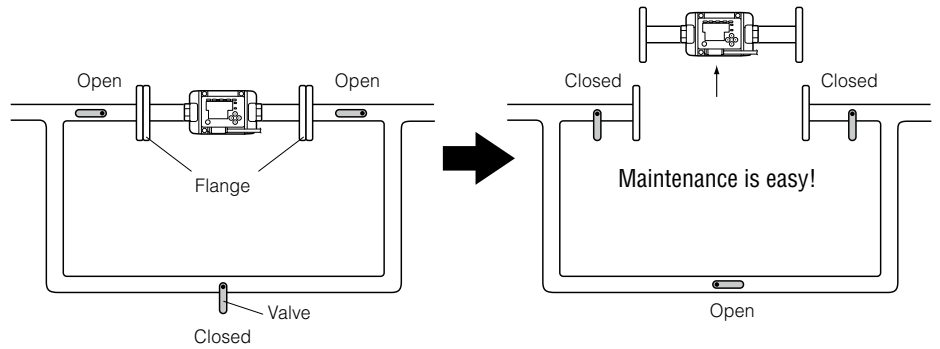

# KEYENCE FLOW SENSOR VARIATIONS

## Non-wetted Electrode Electromagnetic Flow Sensors

FD-M Series [Electromagnetic + capacitive type]

Detection range 0.04 to 264 gal/min (0.15 to 1000 L/min)

Gauge 3/8" RC 3/8" RC/NPT 3/4" RC/NPT  
1" RC/NPT 2" RC

Electrical conductivity : 5  $\mu$ S/cm or more

Wetted materials : SCS13, PPS, FKM

Withstanding pressure [2 MPa]\*

\* The operating pressure range is 1 MPa or lower.



**KEYENCE**

CALL  
TOLL  
FREE

TO CONTACT YOUR LOCAL OFFICE  
**1-888-KEYENCE**  
1 - 8 8 8 - 5 3 9 - 3 6 2 3

[www.keyence.com](http://www.keyence.com)



### SAFETY INFORMATION

Please read the instruction manual carefully in order to safely operate any KEYENCE product.

**KEYENCE CORPORATION OF AMERICA**

669 River Drive, Suite 403, Elmwood Park, NJ 07407 **PHONE:** 888-539-3623 **FAX:** 855-539-0123

**KEYENCE CANADA INC.**

**E-mail:** [keyencecanada@keyence.com](mailto:keyencecanada@keyence.com)

**KEYENCE MEXICO S.A. DE C.V.**

**E-mail:** [keyencemexico@keyence.com](mailto:keyencemexico@keyence.com)

KA11-1125

The information in this publication is based on KEYENCE's internal research/evaluation at the time of release and is subject to change without notice. Company and product names mentioned in this catalog are trademarks or registered trademarks of their respective companies. The specifications are expressed in metric units. The English units have been converted from the original metric units.

Copyright (c) 2011 KEYENCE CORPORATION. All rights reserved.

Flow2-KA-TG-US 1016-1 [611B16] Printed in Japan