

**District of Columbia
Historic Preservation Guidelines**

**ENERGY
CONSERVATION
FOR HISTORIC
BUILDINGS**



Introduction

Conserving energy for environmental and economic reasons is a concern of many owners of Washington's historic buildings. An energy conservation strategy should begin with evaluating the inherent energy conserving features of a historic building. The strategy should include an evaluation of the thermal efficiency of the foundations, walls, roof, windows and doors.⁽¹⁾ An energy conservation strategy should also include a complete evaluation of a building's energy consumption for heating, cooling, lighting, appliances and the like.

Energy Conserving Features of Historic Buildings

The vast majority of Washington's historic buildings were constructed before modern heating, ventilating and air conditioning (HVAC) systems were invented. Instead, their architects and builders incorporated many energy conserving features into the buildings to help them retain heat in the winter and stay cool in the summer. Among the most common energy conserving features of historic buildings are operable window, transoms, shutters, porch roofs, ceiling fans, awnings, attic vents, dormers, high ceilings and party wall construction. Trees and other landscaping were often used to maintain a comfortable environment inside the building. Maintaining these and other inherent energy conserving features of historic buildings and landscapes not only helps to reduce energy consumption, it also preserves the character of historic buildings and districts.

1). Thermal efficiency is the measure of the rate at which heated or cooled air is transmitted or conducted through materials.

Types of Operable Windows

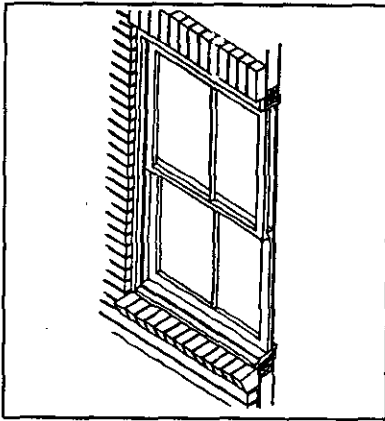

Double hung

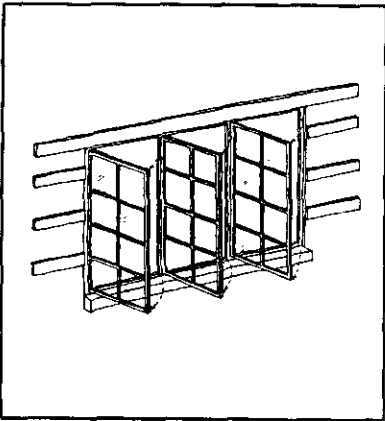

Casement

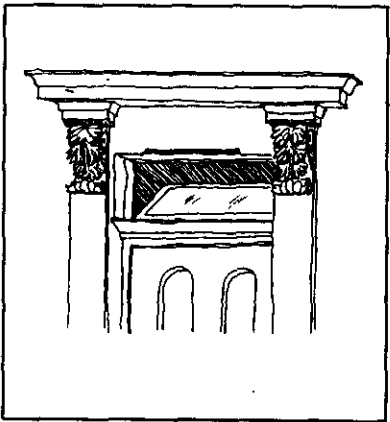

Transom

Operable Windows and Shutters

Double hung, casement, transom and other types of historic operable windows help to keep a building cool in the summer. In addition to creating a pleasing exterior appearance, they were located to maximize the movement of air. When used in association with ceiling fans, operable windows made all but the worst summer days tolerable.

Operable windows on residential buildings often contain shutters that can be closed. Historic shutters contain a series of downward sloping wood slats in a wood frame that allow air to circulate but block the direct rays of the sun from the interior. Historically, shutters were rarely used on commercial, institutional or governmental buildings.

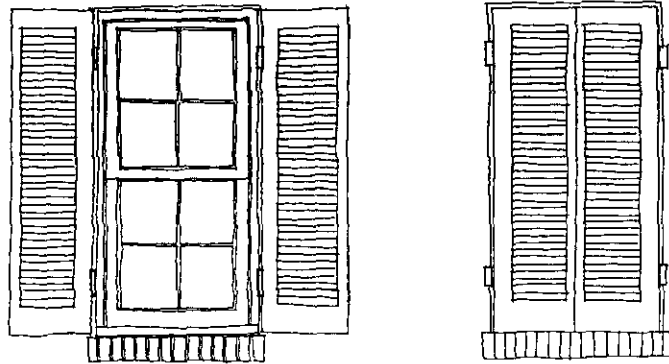

Downward sloping wood slates allows air to circulate, while shielding the interior from direct sunlight. When closed, shutters should cover the entire window opening.

Storm Windows and Screens

Historic residential buildings often contain removable storm windows to increase thermal efficiency during the winter. In the summer they are replaced by screens to allow air to circulate without allowing insects into the interior.

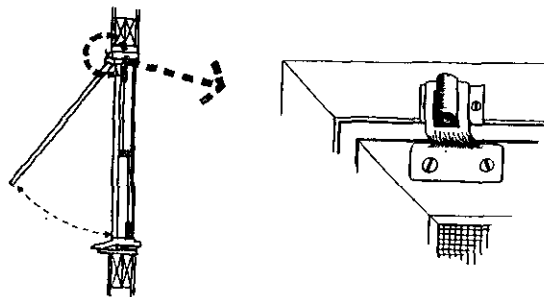

Removable storm windows and screens are hung on the outside of historic windows.

Porch Roofs

Many of Washington's rowhouses and free-standing residential buildings have front porches and sometimes side and rear porches. Most historic porches have roofs to provide shade from the sun and shelter from rain and snow. The sides of historic porches are almost always open, allowing air to circulate and providing a pleasant place to sit on summer evenings.

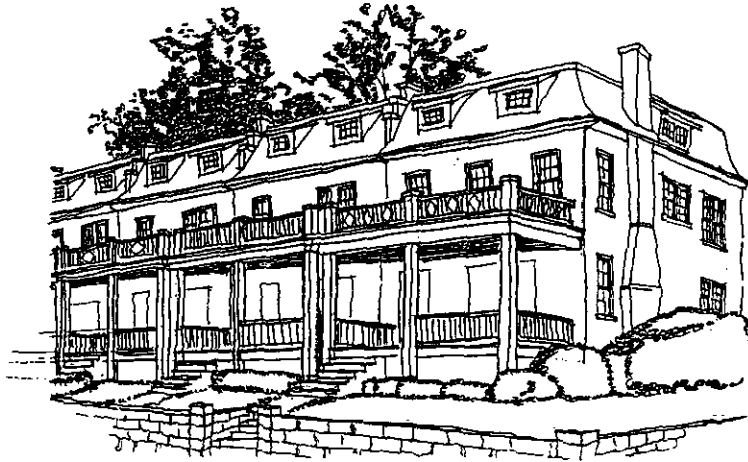

Porch roofs shade windows and walls from direct sunlight.

Awnings

Many of Washington's historic storefronts have awnings to protect pedestrians from rain and snow. Awnings also shade large display windows from direct sunlight, helping to keep the interior cool and protecting displayed merchandise from fading. Many storefront awnings are designed with retractable frames. In the winter, awnings are often retracted so sunlight can help to warm the interior.

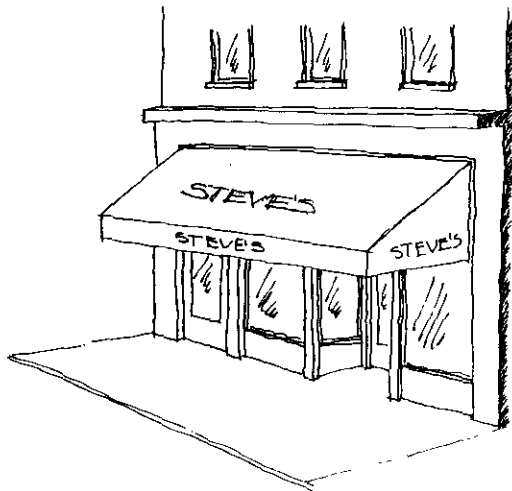

Awnings on storefronts shade display windows and protect pedestrians from rain and snow.

Attic Vents and Dormers

During the summer, attic vents allow hot air to escape to the outside, helping to cool a building. During the winter, closing the vents helps conserve heat. Operable dormer windows serve the same function as well as allowing light into an attic. Often they are equipped with reversible fans to circulate air through the attic. (2)

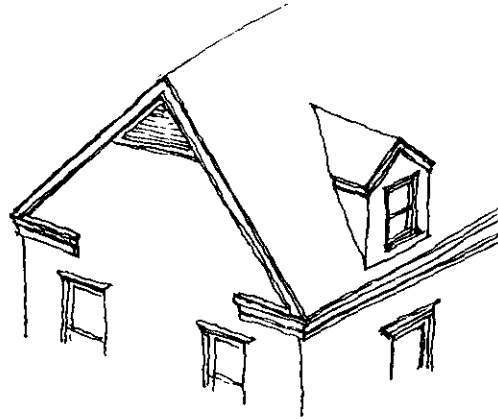

Attic vents and dormers help cool a building in the summer.

Landscaping

Landscaping was historically used to modify the climate immediately around buildings. For example, deciduous trees were often planted on the south and west sides of historic buildings to shade walls and roofs from the summer sun. In winter, after the leaves have fallen, warming rays of the sun striking the building help to warm the interior. In other cases, evergreens were planted to protect a building from winter winds.(3)

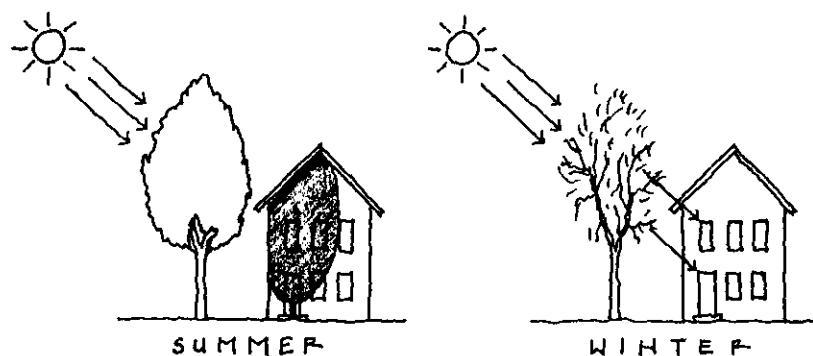

Landscape features contribute to cooling and heating a building.

2). For further information on attic vents and dormers, see ***Windows and Doors for Historic Buildings***.

3). For further information on landscaping, see ***Landscaping, Landscape Features and Secondary Buildings in Historic Districts***.

Building Envelope

Reducing heat gain in summer and heat loss in the winter by upgrading the thermal efficiency of the building envelope is often a way to conserve energy in a historic building.⁴⁾ Before deciding how to improve the thermal efficiency of a building's envelope, the owner should determine where heating and cooling loss and gain is occurring. The owner should also determine how much is occurring in each location. For example, in a typical free-standing residential building the majority of heating and cooling loss occurs through the roof and windows, with less occurring through walls, foundations and doors. Because a typical rowhouse and other party-wall buildings have only two exposed walls, the majority of heating and cooling loss and gain is through the roof.

The thermal efficiency of a building envelope is also influenced by the types of materials employed. For example, an uninsulated brick wall is far more efficient than an uninsulated wood wall because brick is denser than wood. Similarly, white gravel used as ballast for a built-up roof is better at preventing heat gain than gray or black gravel because it will reflect rather than absorb sunlight.

In most cases, increasing the thermal efficiency of a building envelope is achieved by adding insulation to foundations, walls and roofs. Thermal efficiency may also be increased by sealing gaps around windows and doors and by adding storm windows and doors. It is very important that modifications to improve the energy efficiency of a building do not alter its historic character and that the methods and materials employed do not create future maintenance problems.

Foundations

In Washington, only a small percentage of heat loss is through foundation and basement walls into the ground. This is due to the density of most foundation materials as well as to the city's relatively high ground temperature during the winter. Thus it is almost never cost effective to increase the thermal efficiency of foundation and basement walls by adding insulation.

However, if a building owner has determined it is appropriate to insulate foundation and basement walls, it is usually less expensive to install the insulation on the interior rather than on the exterior. Insulating the interior of a basement or foundation wall typically requires that a new non-structural wall be built next to the existing structural wall to hold the insulation in place. If the materials or finishes of the existing foundation or basement wall

4). A building's foundations, walls, roof, windows and doors are referred to collectively as the building envelope.

Types of Insulation

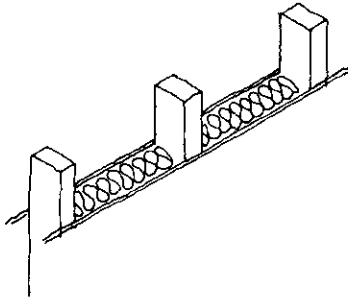

Batt insulation in wood studs.

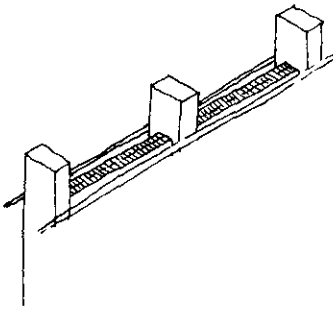

Rigid insulation in wood studs.

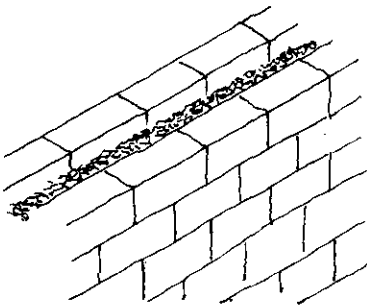

Blown-in insulation in a masonry cavity wall.

5). Walls containing an air space between the interior and exterior surfaces are known as cavity walls.

6). The dew point is the temperature and humidity levels at which moisture in the air condenses.

are important to the character of the building, installing insulation on the interior may not be appropriate. Alternatively, the insulation can be installed on the exterior of the foundation. This will require exposing the wall at least thirty inches below grade (the frost line in the Washington area), potentially disturbing historic landscaping.

Walls

Adding insulation to existing walls will increase their thermal efficiency, but may also lead to future maintenance problems as well as destroy historic materials, features and finishes. The three most popular forms of wall insulation are batt, made from fiberglass attached to a paper or foil backing; rigid, made from expanded polystyrene and other materials; and blown-in, made from loose fiberglass or cellulose. All three are typically inserted into the air space between the inside and outside surfaces wood and masonry walls.(5)

Adding batt or rigid insulation to existing walls requires that either exterior or interior surface material be removed. In almost all cases, this will destroy the existing material. Thus installing batt or rigid insulation in existing walls should probably not be considered. However, if the surface material is already missing or damaged beyond repair, installing batt or rigid insulation may be appropriate.

Because extensive damage to character-defining elements will occur if batt or rigid insulation is added to existing walls, most building owners should consider using blown-in insulation. Typically, fiberglass or cellulose is blown into the cavity through small holes drilled on the exterior. When the work is finished the holes are patched in-kind; that is, using the same wall material.

However, blown-in insulation is not without problems. Over time it may settle to the base of the wall, thus reducing its thermal efficiency. Adding insulation of any type will also change the dew point within the wall.(6) This may cause wood members to rot, exterior and interior paint to blister and wallpaper to peel. If cellulose is used as insulation, it may absorb water thus increasing the likelihood of future maintenance problems.

Condensation within the wall cavity can sometimes be prevented by installing air vents at the top and bottom of the exterior wall. While this allows air to circulate, reducing the risk of condensation, it also reduces the thermal efficiency of the insulation. The placement and design of vents must be carefully considered so that they do not inappropriately change the historic character of the wall.

The best way to prevent condensation in a wall cavity is to install a vapor barrier on the warm (interior) side of the wall. Vapor barriers are made from thin sheets of polyethylene or metal

foil. They are particularly important in cavity walls adjacent to bathrooms, kitchens and other rooms likely to contain moist air. It is also important that the vapor barrier be sealed around receptacles, switches, windows and doors to prevent moist air from entering the cavity. Installing a vapor barrier to control condensation will require removing the interior surface, potentially destroying character-defining materials, features and finishes.

Given the problems associated with installing insulation in existing walls and the relatively minor increase in thermal efficiency often achieved, it is typically best to concentrate energy efficiency measures on the roof, windows and doors.

Windows and Doors

Building owners who wish to upgrade the thermal efficiency of windows and doors should consider installing weatherstripping and caulking to decrease air infiltration through cracks and joints, as well as installing storm windows and doors to decrease thermal conductivity through the glass.

Historically, weatherstripping for doors was made from thin strips of copper or other metal attached to the jambs and head. Weatherstripping for windows was made from metal or felt, sealing the joint between the frame and sash. Modern weatherstripping is made of copper, or of neoprene or other synthetic material. If the existing weatherstripping is deteriorated, it should be replaced in-kind. If it is missing, or never existed, new weatherstripping can usually be added without altering the existing character of the door or window.

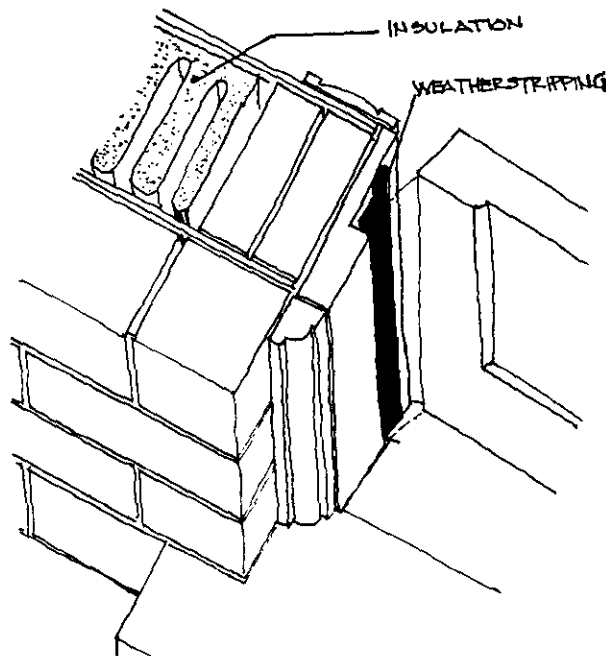

Weatherstripping and insulation are used to improve energy efficiency in historic buildings.

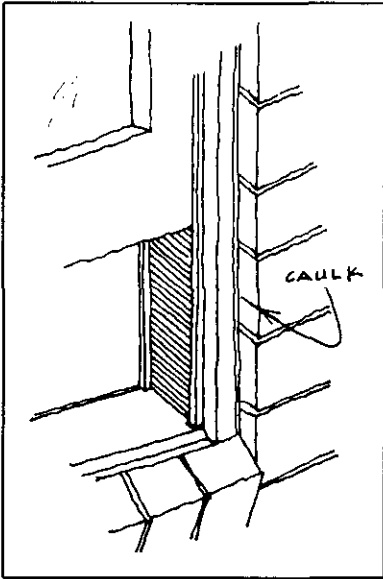

Caulking is used to seal the joints between window frames and walls.

Synthetic caulking is a relatively modern material used to seal the joints between window and door frames and the wall opening. It can usually be added without altering the character of the door, window or wall. However, care should be taken to select caulking that is chemically compatible with surrounding materials and is colored to blend in with existing walls, windows and doors.

Exterior or interior storm windows may be added to improve the thermal efficiency of windows. If exterior storm windows are used, they should match as closely as possible the size, shape, profiles, color and other character-defining features of existing windows. Clear glass rather than reflective or tinted glass should be used.

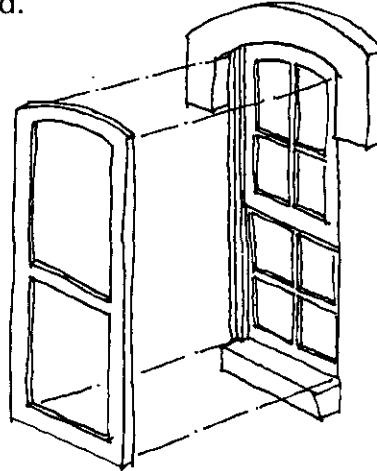

Exterior storm windows should match the character-defining features of existing windows.

If interior storm windows are used, they should also match the size, shape, color and profiles of the existing window as closely as possible. However since they are installed on the inside, a single pane of glass may be used rather than matching the major divisions of the existing window. Care should be taken to ensure that the window is properly vented so that condensation does not occur.

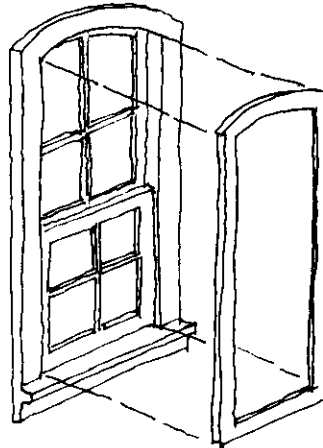

Interior storm windows should fit within the existing frame.

It may also be possible to improve the thermal efficiency of existing windows by adding another layer of glass to the sash. If this method is selected, it is important that the existing profile of the sash, frame and muntins remains unaltered.

If existing windows are so badly deteriorated that they must be replaced, the building owner should consider installing double- or triple-pane thermal windows. The new windows should match as closely as possible the size, shape, number of lights, profiles and other character-defining features of the existing windows. The glass should have the same reflectivity as the existing, although clear, low E-glass may be used.

Adding new storm doors will also help improve the thermal efficiency of a building. New storm doors should match the size, shape, color, profiles and other character-defining features of existing doors as closely as possible. Clear, not reflective or tinted glass should be used. In some cases, tempered glass may be required by the District of Columbia building code.

It also may be possible to add an interior vestibule to improve the thermal efficiency of a door. The design of the interior vestibule should be compatible with the character of the door and the interior space, and its installation should not adversely affect character-defining materials, features or finishes. If a historic vestibule has been removed it should be replaced. Adding a new exterior vestibule is not generally appropriate since it will alter the historic character of an existing door. (7)

Roofs

In many cases adding insulating to a sloping roof is the most cost effective way of conserving energy in a historic building. Batt, rigid and blown-in insulation can usually be installed easily between attic rafters. It is important that a vapor barrier be installed along with the insulation to eliminate potential problems caused by condensation. In addition, it is also often necessary to add vents to eaves, gable ends or ridges to prevent condensation from occurring.

Roof insulation often can be added to a flat roof building without altering its character. If space exists between the ceiling and the underside of the roof deck, rigid or batt insulation and a vapor barrier can be installed. If space does not exist, or access to the space would require removing a character-defining ceiling, feature or finish, rigid insulation can be installed on top of the roof deck. If this method is selected, it is important that the insulation is chemically compatible with the roof deck and membrane, that it is appropriate for this application, and that it is sloped toward drains and gutters.

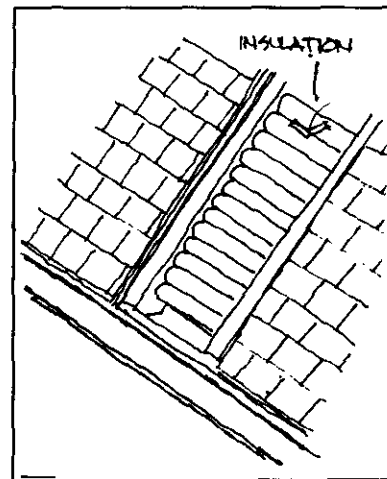

Batt insulation is typically installed between attic rafters.

7). For further information on historic windows and doors, see *Windows and Doors for Historic Buildings*.

In some cases it may be appropriate to add operable skylights, vents or dormer windows to roofs to increase air circulation in attic spaces during the summer. If skylights or vents are installed on a flat roof they should be located so that they can not be seen from the public street and do not destroy character-defining interior materials, features or finishes. If skylights, vents or dormers are installed on sloping roofs, they should be located on rear slopes that are not visible from a public street and are designed to be compatible with the character of the roof.(8)

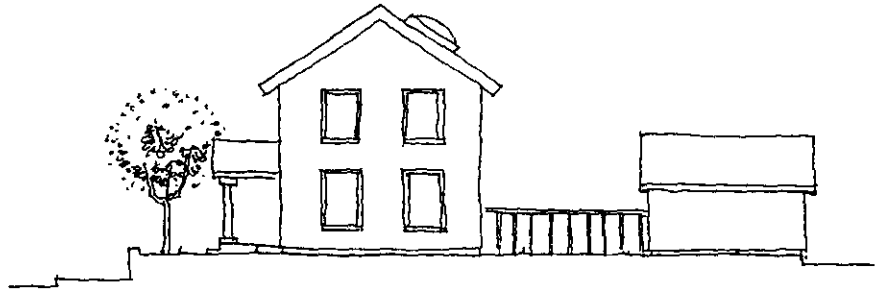

Skylights should be located so they cannot be seen from a public street.

Building Systems

HVAC Systems

In 1744, Benjamin Franklin introduced his "Franklin Stove" leading to 250 years of improvements in heating systems for buildings.(9) In the 1840s, ventilating equipment was introduced into hospital buildings to improve air quality. In the 1920s, John Carrier perfected the first practical air conditioning system, allowing buildings to be comfortable in summer.

Heating, ventilating and air conditioning systems have three major components: the radiators, vents and grilles that help define the character of rooms; ducts and pipes that are typically buried in walls and ceilings; and furnaces, boilers and chillers that are located in basements, attics, on top of roofs or in yards. In most cases, upgrading or replacing the furnace, boiler or chiller with new energy efficient models will improve energy conservation without altering the character of a building. On the other hand, adding a new chiller located on the roof or in the yard may change a building's character. A roof mounted chiller should be located so it cannot be seen from a public street.(10) A ground mounted chiller should be located in the rear yard or screened if it can be seen from a public street.

8). For further information on roofs, see *Roofs on Historic Buildings*.

9). Also known as a "Pennsylvania Stove".

10). For further information on roof mounted HVAC systems, see *Additions to Historic Buildings*.

In most cases replacing furnaces, boilers or chillers will not require altering existing pipes or ducts nor will it require replacing existing radiators, grilles or vents. If, however, the distribution system must be replaced, care should be taken to remove as little character-defining wall and ceiling materials and finishes as possible. After the new pipes or ducts are installed, the wall and ceiling should be replaced exactly as it was originally.

Adding a new central air conditioning system to a historic building will usually not conserve energy, but it will improve the building's livability. If the new central air conditioning system replaces individual, through-window units, it will also improve the character of the exterior. Care should be taken in designing the distribution system and locating grilles and vents so that important interior materials, features and finishes are not disturbed. The design of new grilles and vents should be compatible with the existing character of the interior. It is also important to carefully locate and design the chiller so that it does not adversely affect the exterior character of the building.

In a few cases, a building owner may decide that it is important to change from one heating system to another; for example, replacing a historic hot water system with a forced air system. Care should be taken to ensure that the new system does not dramatically alter the relative humidity of the interior, since this may result in future maintenance problems.⁽¹¹⁾

Water Heaters and Appliances

A hot water heater is usually the single greatest consumer of energy in a residence. It can be insulated to improve its efficiency, or an older one can be replaced with a new, energy-efficient model without altering the character of a historic building. In addition, low-flow shower heads can be installed to reduce the amount of hot water used. Similarly, other inefficient appliances that do not contribute significantly to the character of a building can be replaced with energy-efficient models.

Lighting

One of the easiest, least expensive and least intrusive methods of conserving energy in a historic building is to replace existing light bulbs or fluorescent tubes with energy-efficient models. In most cases this can be done without altering a character-defining fixture. In those cases when the color and quality of the light from the historic light bulb contributes to the character of a building, such as lighting in theaters and auditoriums, care should be taken to ensure that the new bulbs or tubes provide a similar quality and color of light.

11). For example, increasing the relative humidity may cause historic woodwork to swell; while decreasing the relative humidity may cause woodwork to shrink and plaster to crack.

The *District of Columbia Historic Preservation Guidelines* were developed under a grant from the Historic Preservation Division, Department of Consumer and Regulatory Affairs, Government of the District of Columbia. They were funded in part by a grant from the United States Department of the Interior, National Park Service. The United States Department of the Interior prohibits discrimination on the basis of race, color, sex, national origin, or handicap. If you believe that you have been discriminated against in any program, activity or facility in this program, or if you desire further information please write to: Director, Office of Equal Opportunity, National Capital Region, National Park Service, U.S. Department of the Interior, 1100 Ohio Drive, S.W., Washington, D.C. 20242, (202) 619-7020. AN EQUAL OPPORTUNITY EMPLOYER M/F/H.