

\$ Wiener Dog

© 2006 by Tien Nguyen

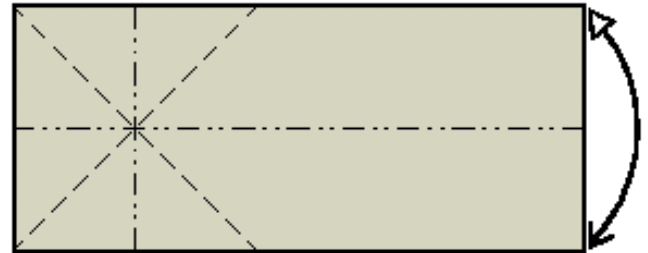

1. Mountain-fold lengthwise and unfold. Form Waterbomb Base at one end for the head.

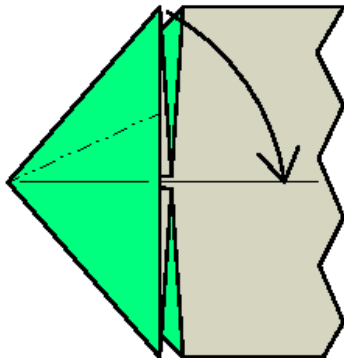

2. Open flap, squash flat to form the ear.

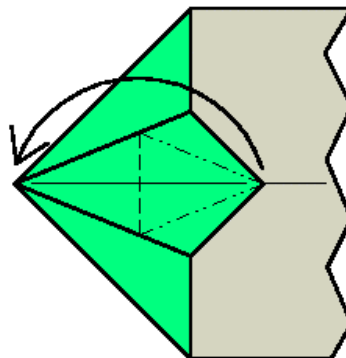

3. Petal-fold.

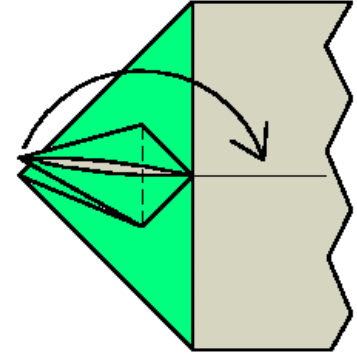

4. Valley-fold.

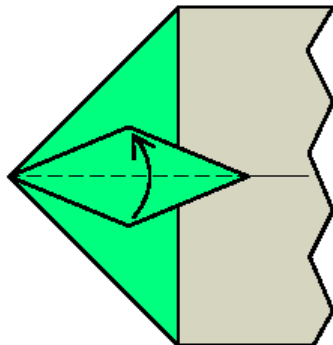

5. Valley-fold. The first ear is complete.

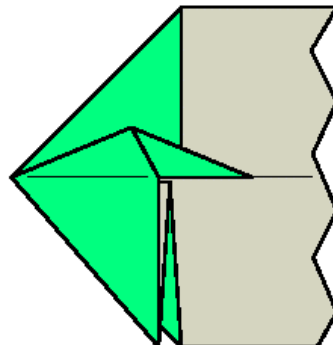

6. Repeat steps 2 through 5 for the other ear.

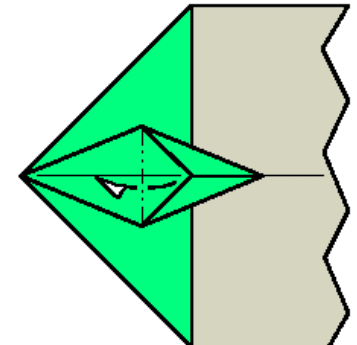

7. Mountain-fold, tucking under to form the head.

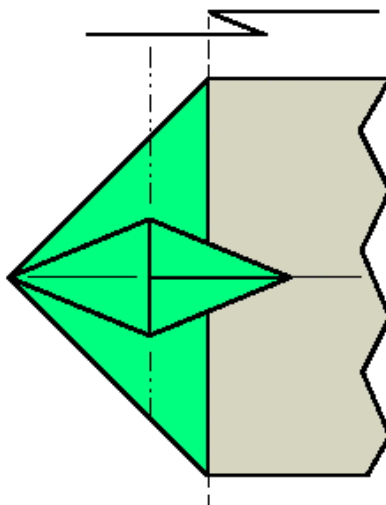

8. Pleat.

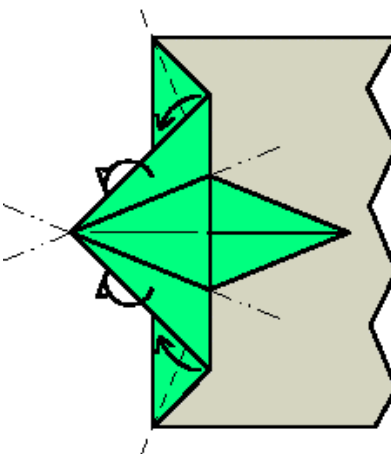

9. Swivel under, narrowing the head.

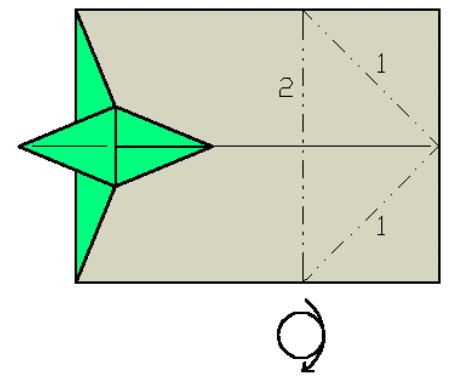

10. Mountain-fold tail portion and turn model over.

\$ Wiener Dog

© 2006 by Tien Nguyen

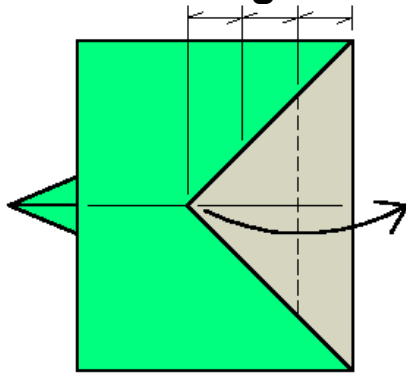

11. Valley-fold the tail at about the 1/3 line.

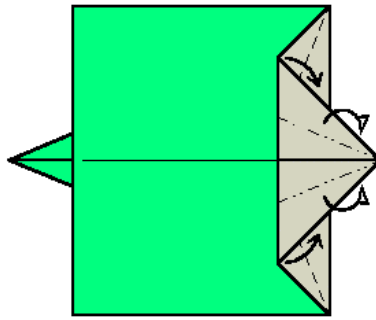

12. Swivel under, narrowing the tail.

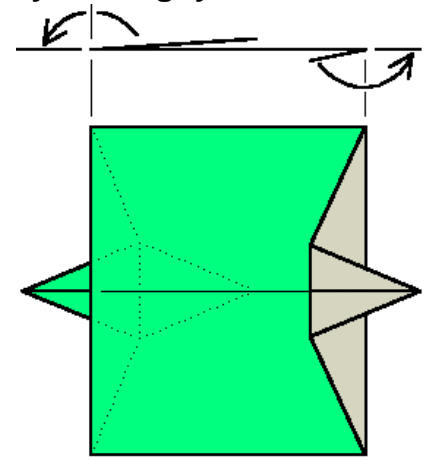

13. Flip the head and tail portion back out.

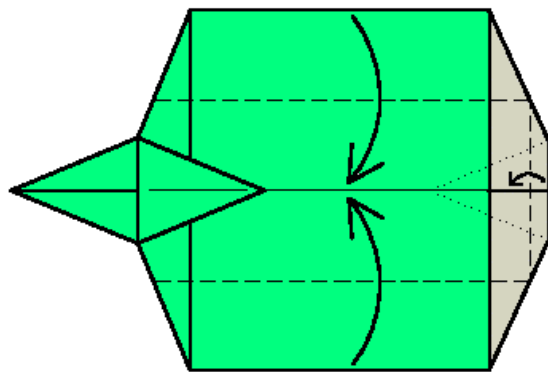

14. Valley-fold, narrowing the body, starting the hind legs.

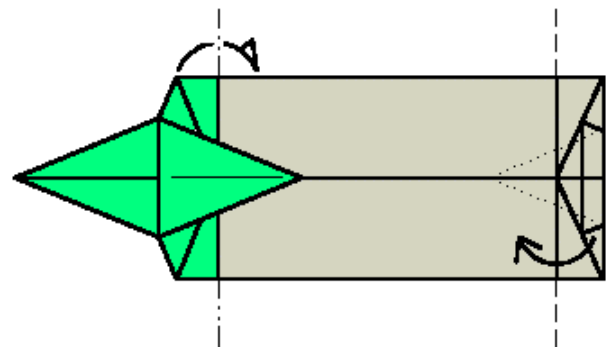

15. Mountain-fold head. Valley-fold tail, forming the hind legs.

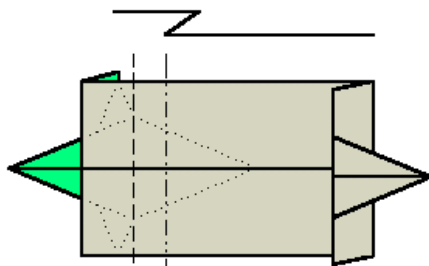

16. Pleat head section to form the forelegs.

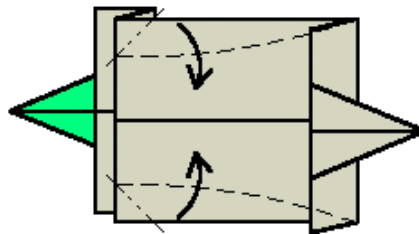

17. Valley-fold along the body and squash behind the forelegs, completing the fore and hind legs.

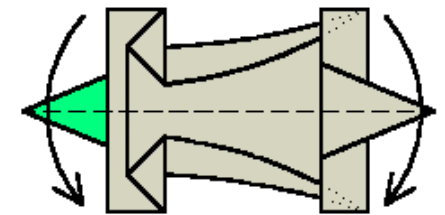

18. Valley-fold the entire model.

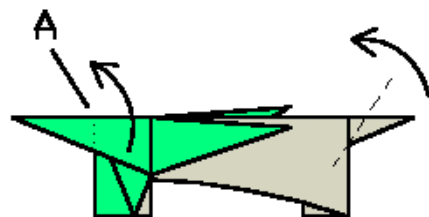

19. Rotate the head around point A, narrowing the forelegs a bit. Re-crease the forelegs to hold the head in place. Outside reverse-fold tail up.

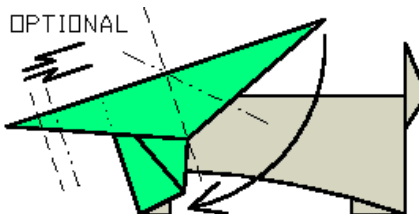

20. Fold ear flaps down, open and squash flat. **Optional:** Pleat the head to form the nose (the paper is very thick in this area).

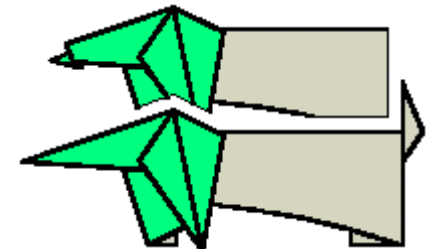

21. Model is complete. Enjoy!