

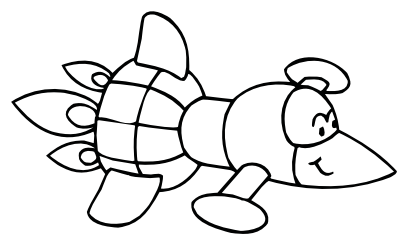

Tarea: Trazamos verticales de arriba hacia abajo
Técnica: Colorear con ceras duras.

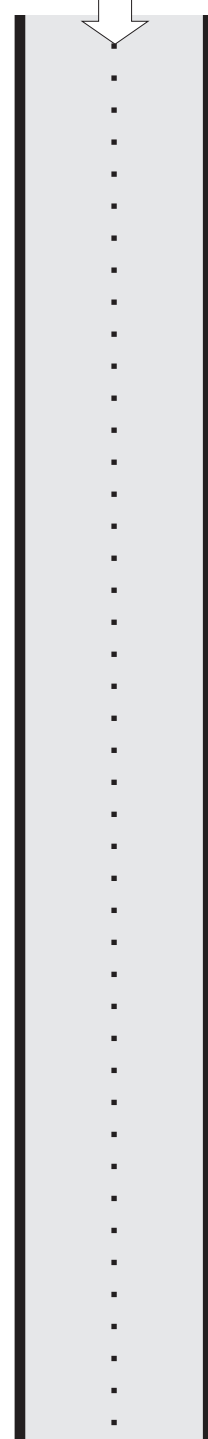

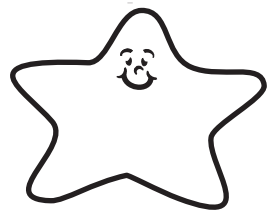

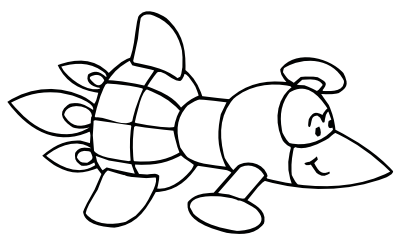
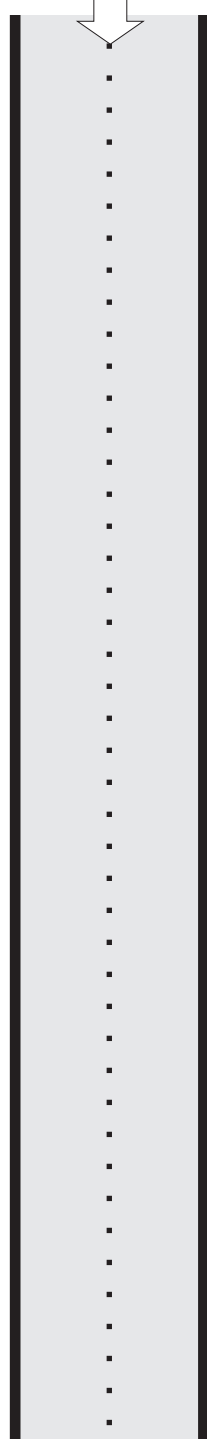
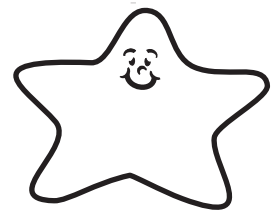
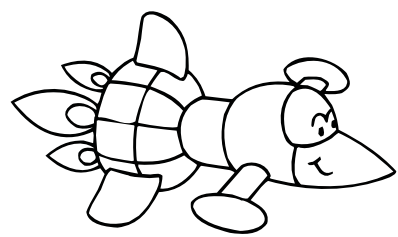
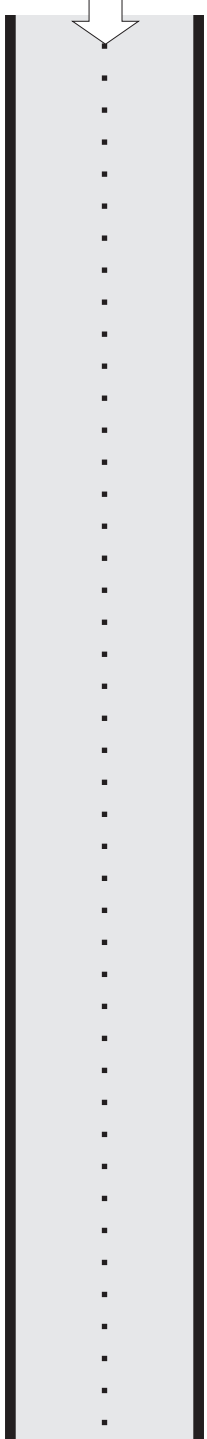
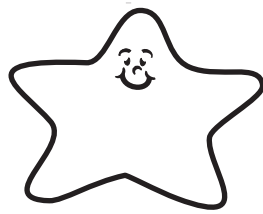
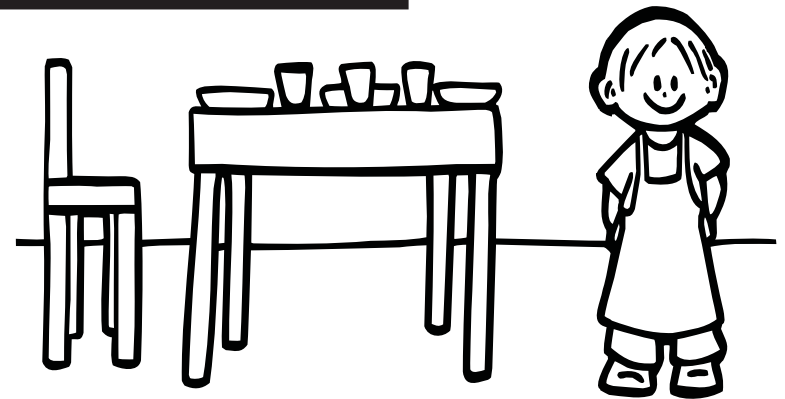
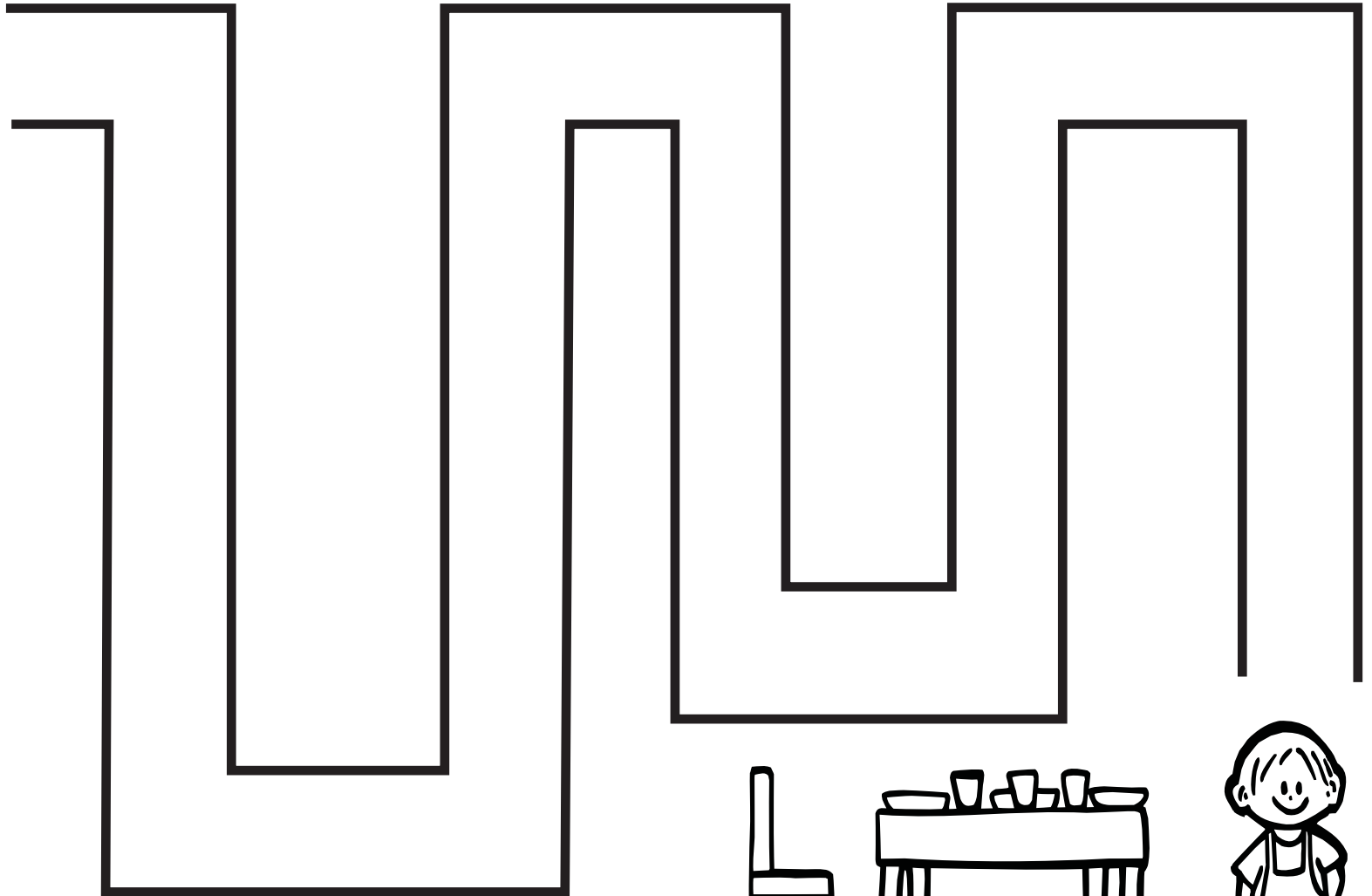
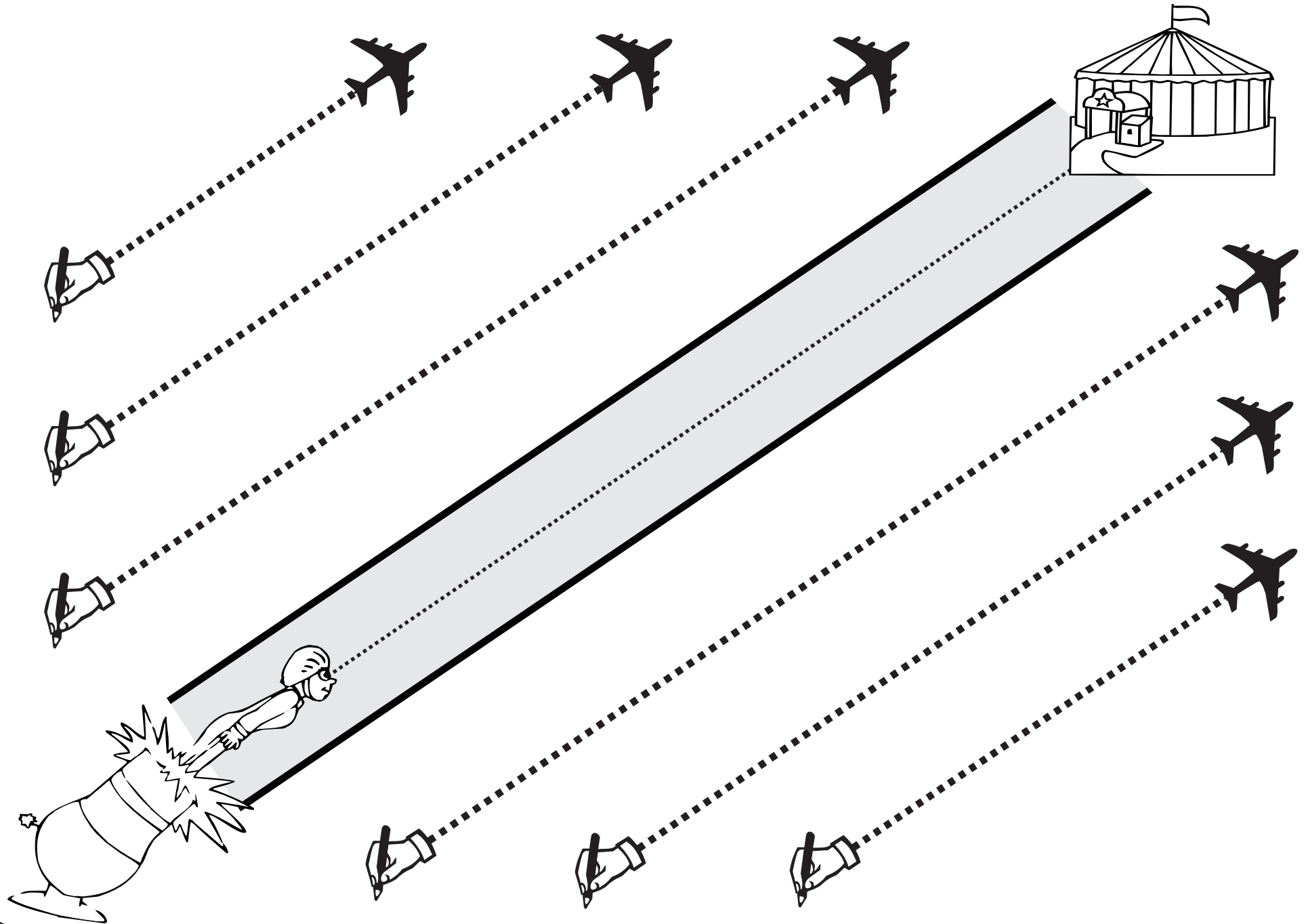

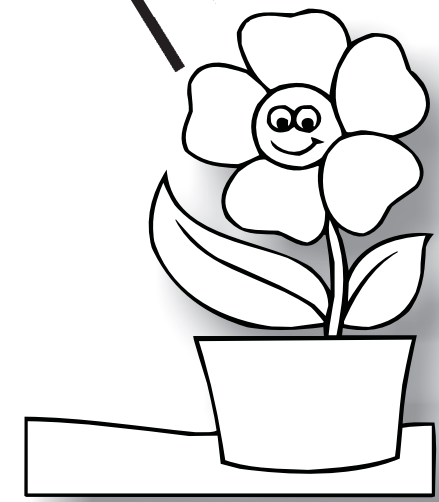
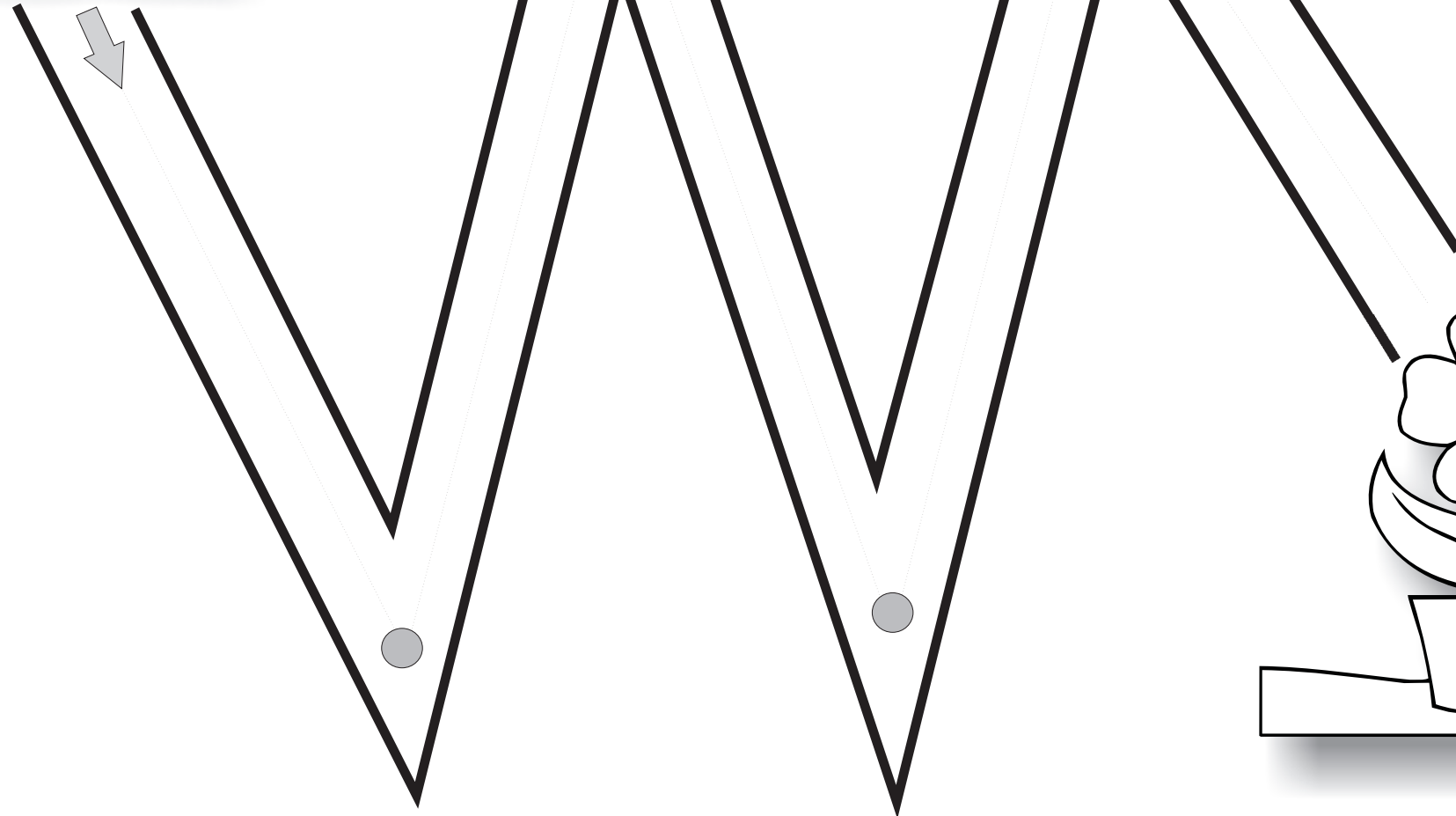

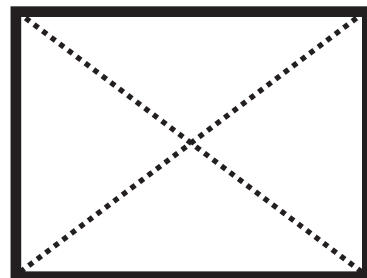
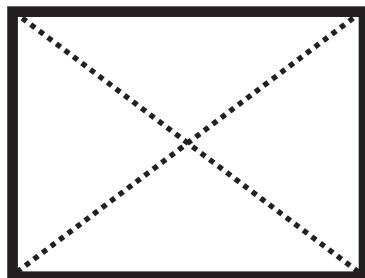
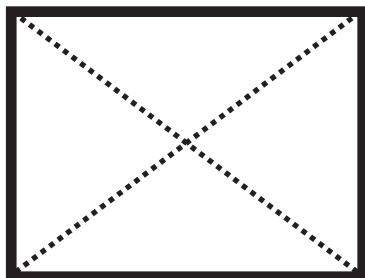
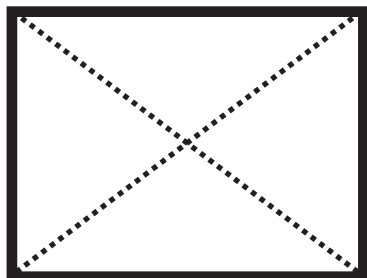
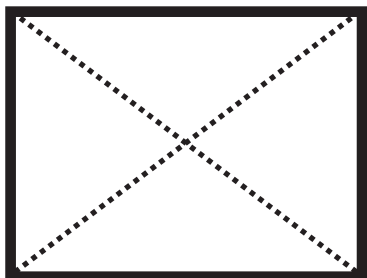
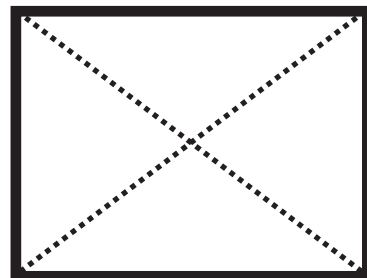
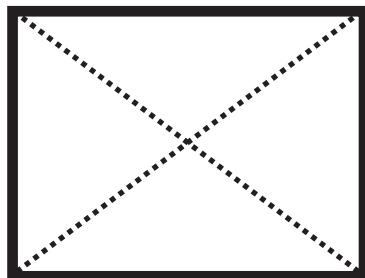
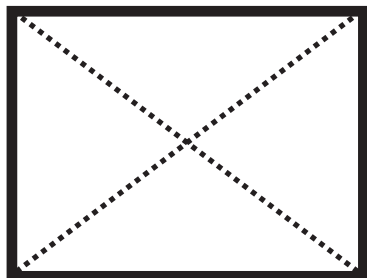
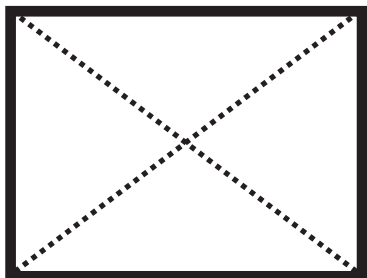
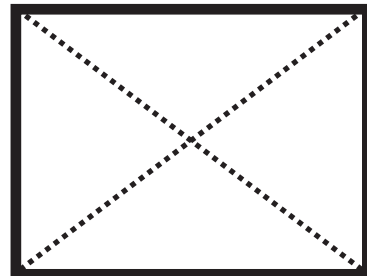
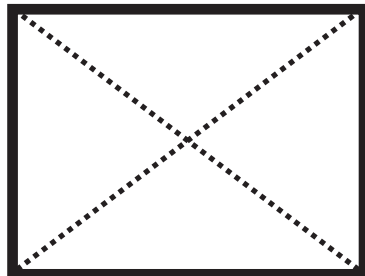
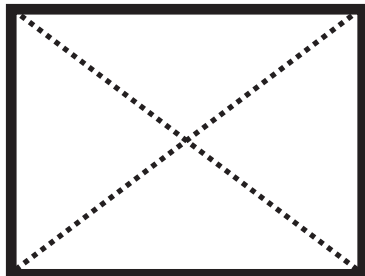
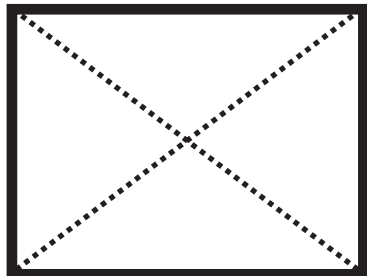
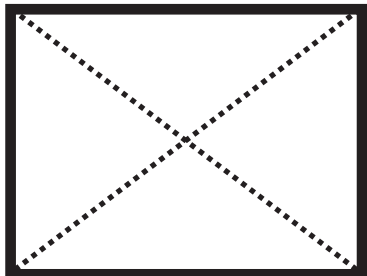



José Alberto

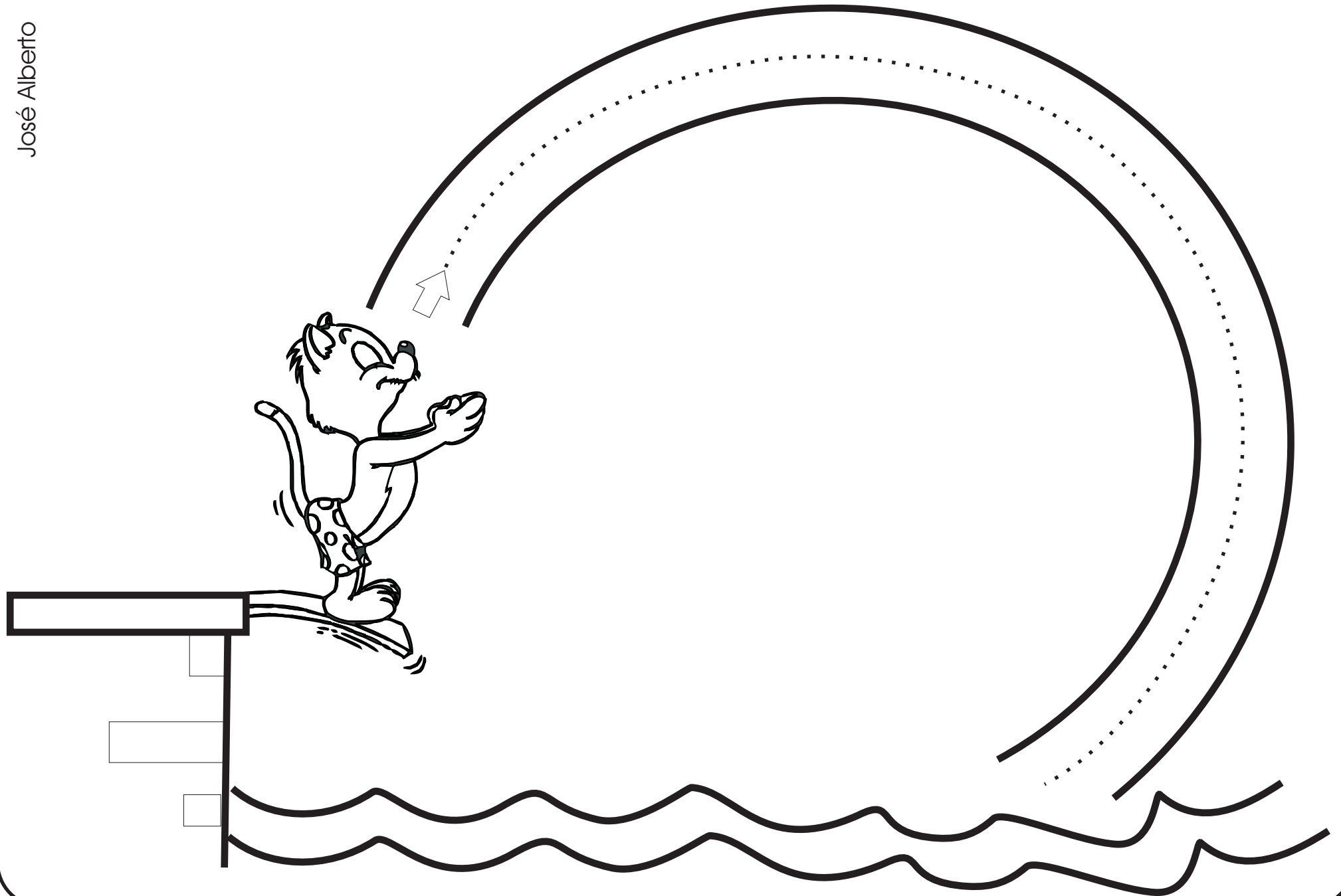

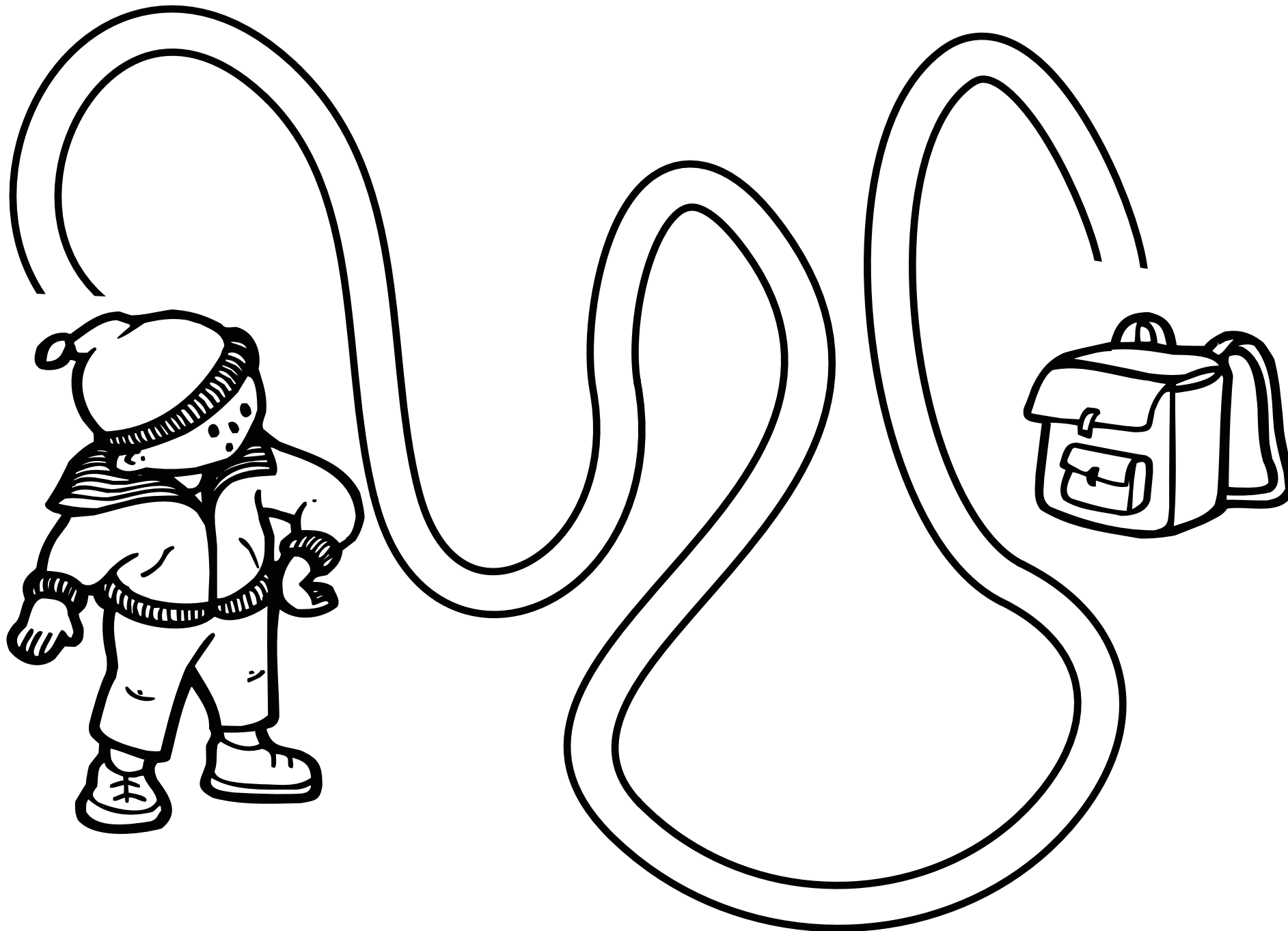

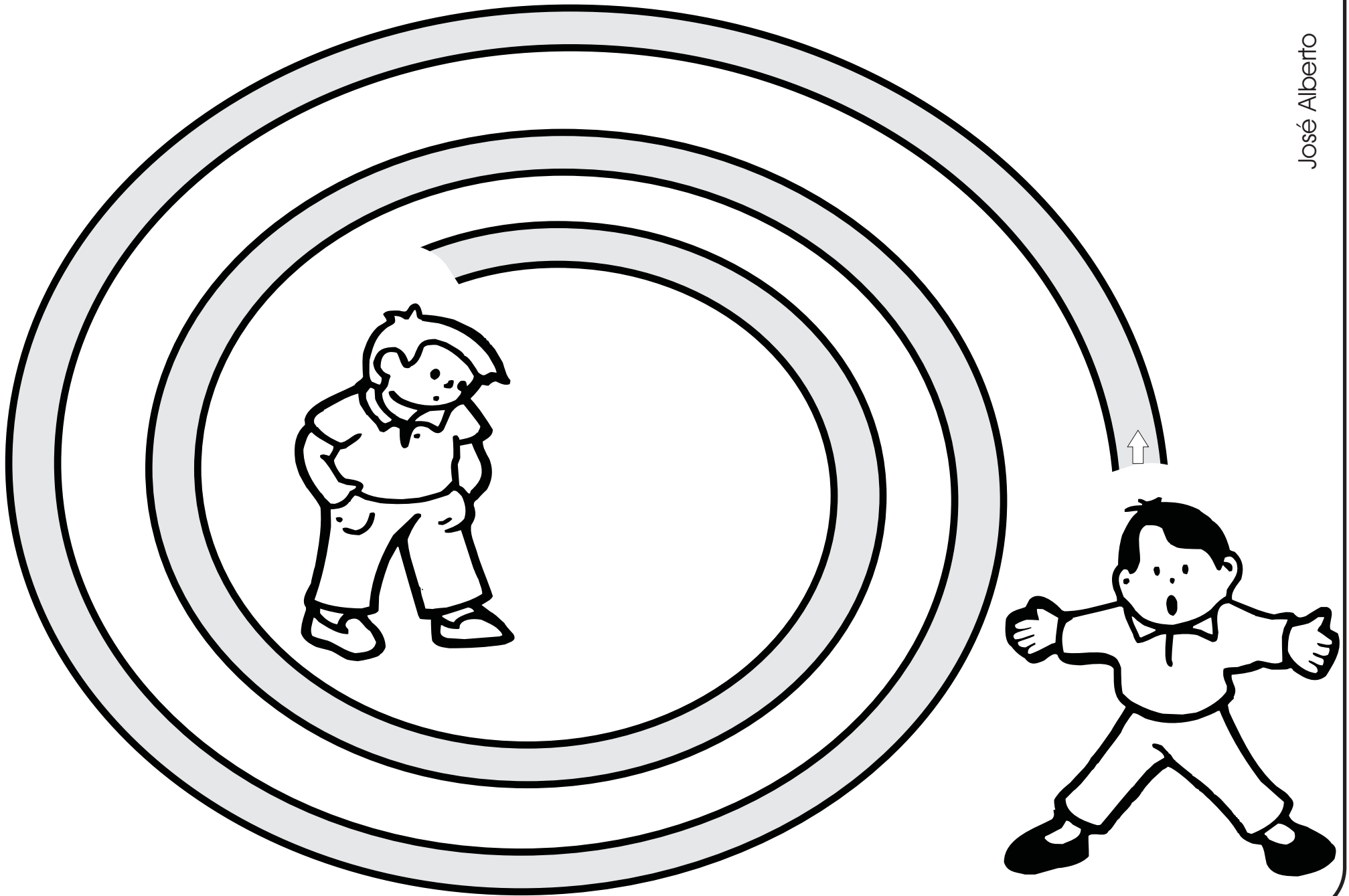

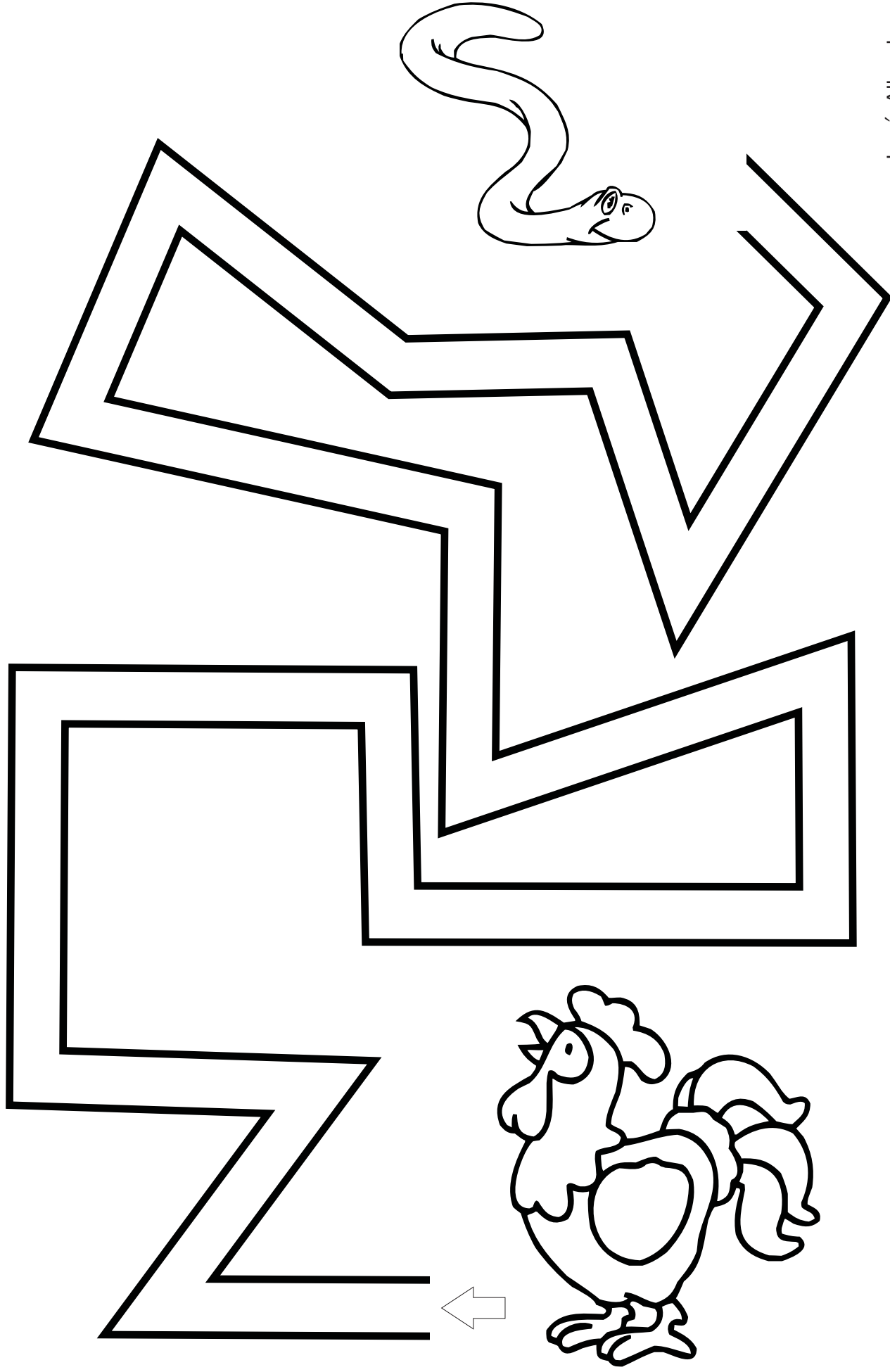

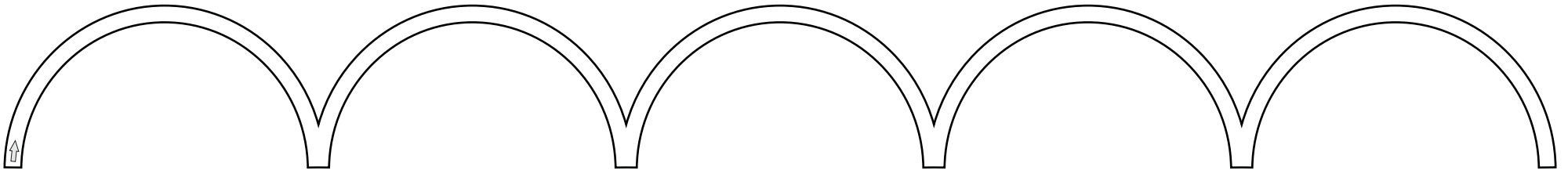
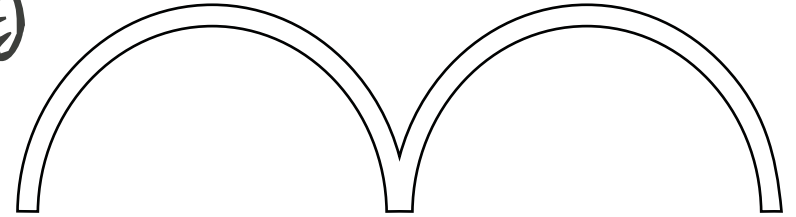
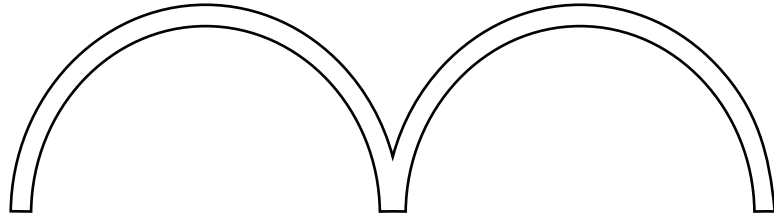
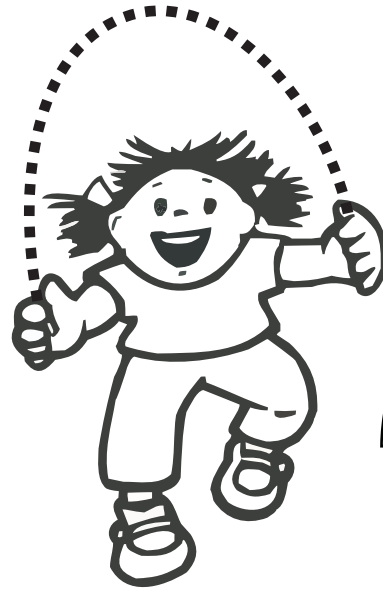



Tarea: Trazamos caminos. Verticales. *Verticalales.*
Técnica: Colorear con ceras duras y picar.

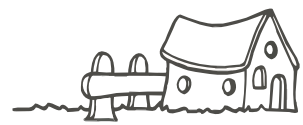
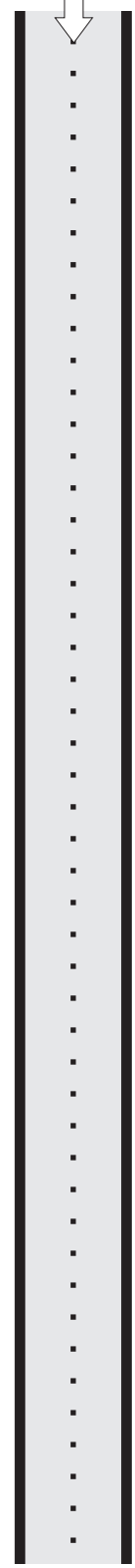
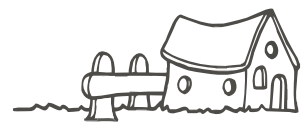
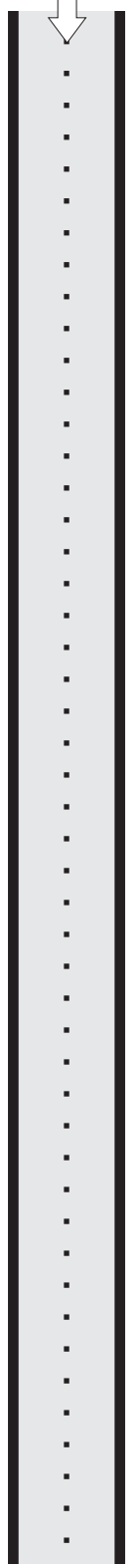

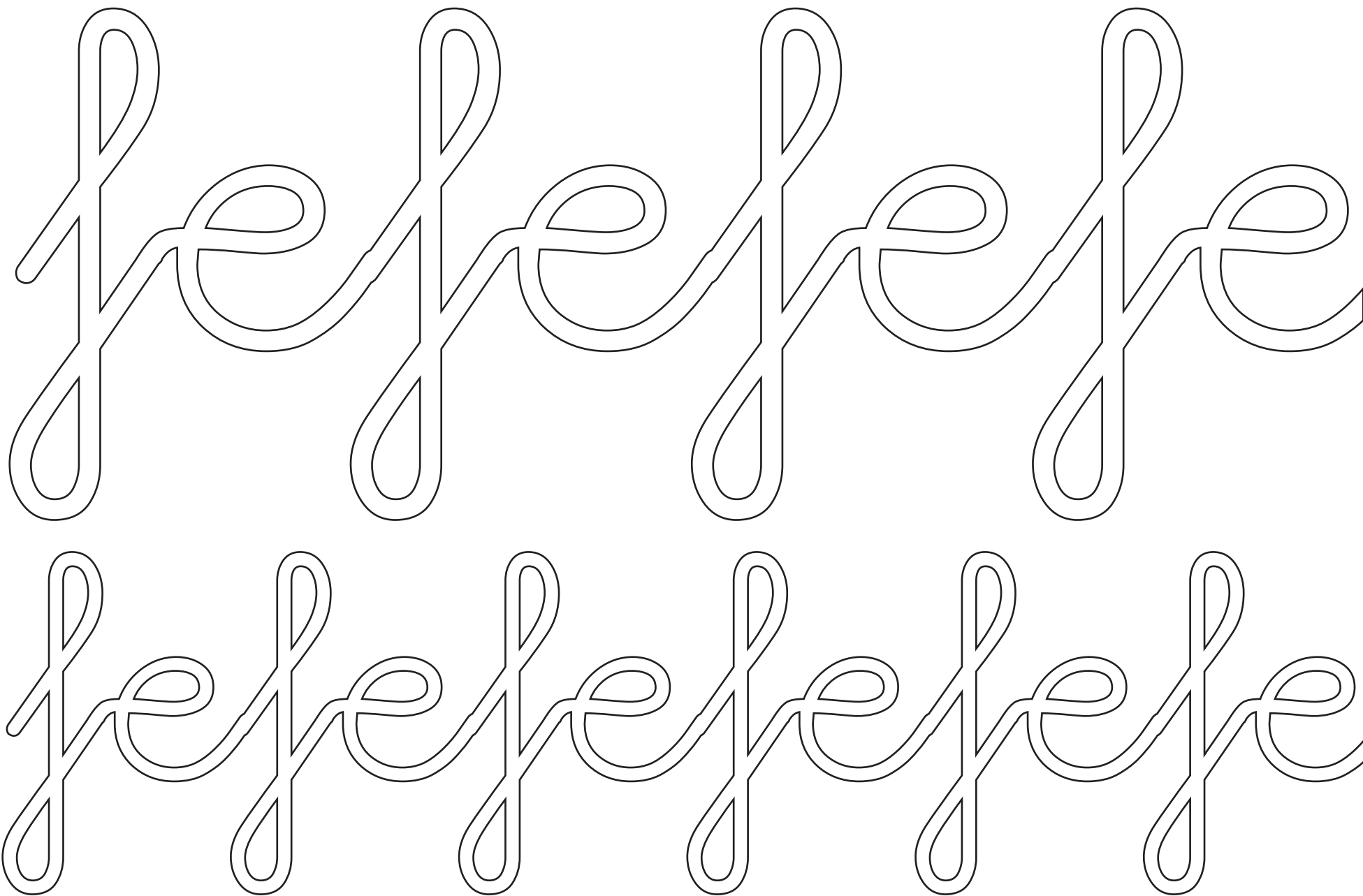

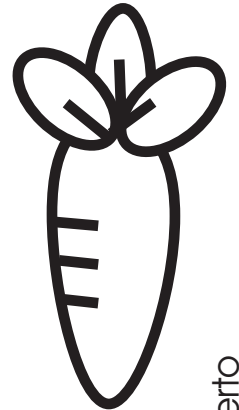
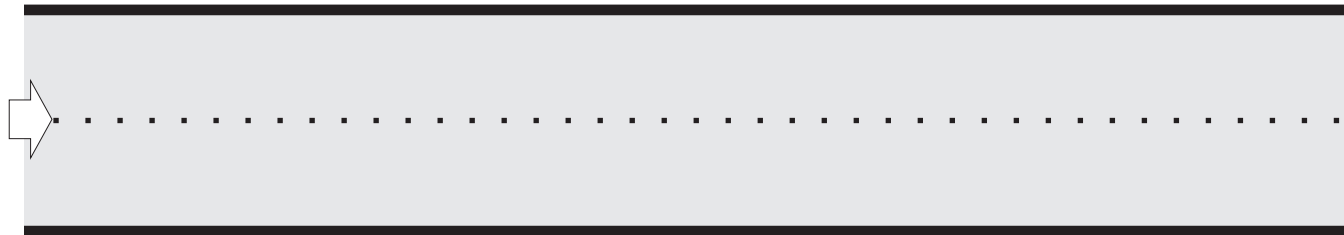
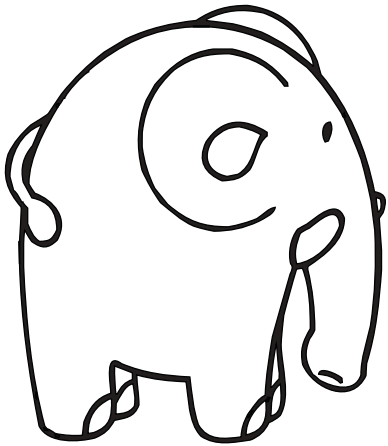
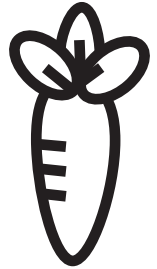
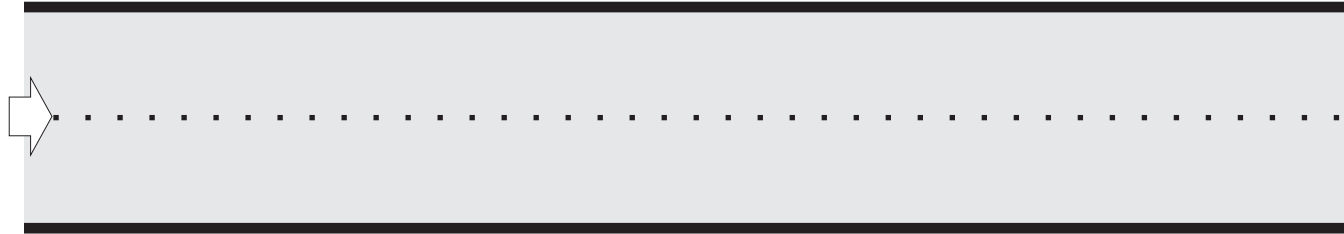

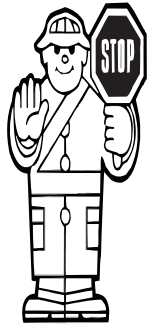
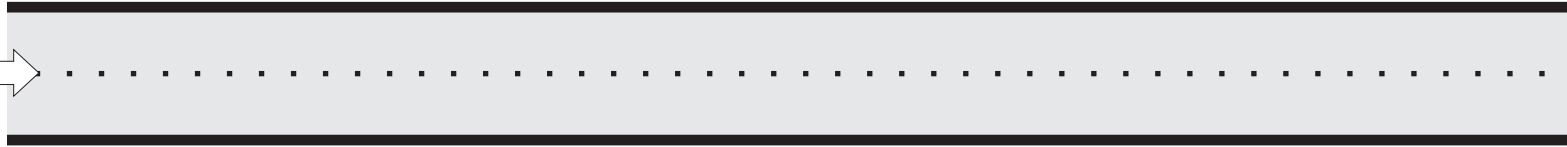
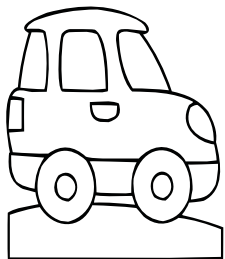
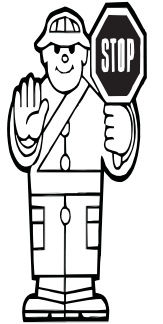
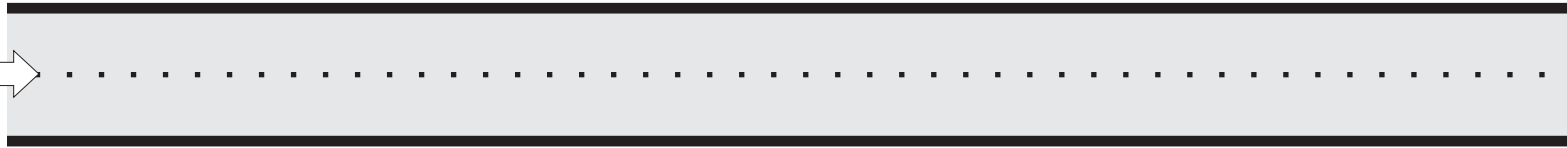
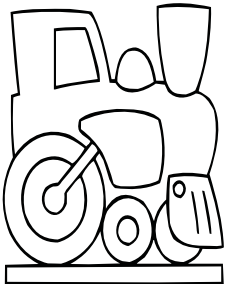
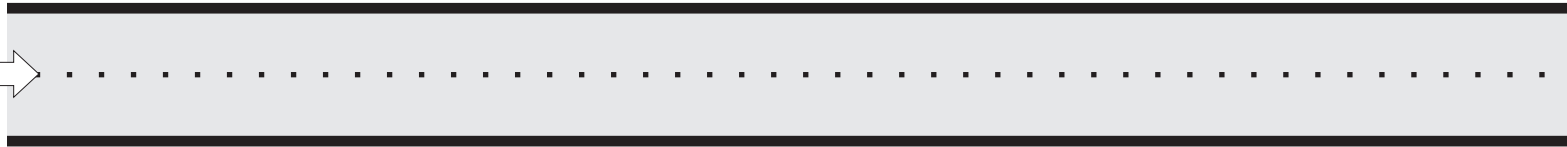
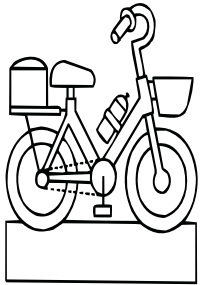



Tracing practice consisting of seven horizontal dashed lines, each starting with a double arrowhead on the left and ending with a solid arrowhead on the right.

