



Testo 350-S Control Unit in combination with
Testo 350-S/-XL Flue Gas Analyzer

Instruction manual

en









General notes

Please read this documentation through carefully and familiarise yourself with the operation of the product before putting it to use. Keep this document to hand so that you can refer to it when necessary.

This document describes the country-specific **GB** version of the testo 350-S measuring system, comprising testo 350-S control unit and testo 350-S flue gas analyzer.

Some functions that are available as an option with the testo 350-S flue gas analyzer are standard in the testo 350-XL. The functionality and handling of both flue gas analysers in combination with the testo 350-S control unit are the same. This means that the functions and operations described here also apply for a testo 350-S control unit in combination with a testo 350-XL flue gas analyzer.

Identification



| Symbol | Meaning | Comments |
|--|--|--|
|  Warning! | Warning advice: Warning! Serious physical injury could be caused if the specified precautionary measures are not taken. | Read the warning advice carefully and take the specified precautionary measures! |
|  Caution! | Warning advice: Caution! Slight physical injury or damage to equipment could occur if the specified precautionary measures are not taken. | Read the warning advice carefully and take the specified precautionary measures! |
|  | Important. | Please pay particular attention. |
| Text | Text appears on the instrument display | - |
|  | Key | Press the key. |
|  | Function key with the function Print . | Press function key. |
|  → xyz | Short form for operating steps. | See <i>Short form</i> , p. 3. |

Short form

This document uses a short form for describing operating steps (e. g. calling up a function).

Example: Calling up the **Diagnostic** function

Short form:

1  → **Device** → .

(1) (2) (3)

2 **Diagnostic** → .

(4) (5)

Steps required:

1 Open Main menu: .

2 Select menu item **Device**: , .

3 Confirm selection: .

4 Select function **Diagnostic**: , .

5 Confirm selection: .



Content

| | |
|--|-----------|
| General notes | 2 |
| Content | 4 |
| A. Safety instructions | 7 |
| B. Intended purpose | 9 |
| C. Product description | 10 |
| C.1 Control Unit | 10 |
| C.1.1 Control unit overview | 10 |
| C.1.2 Keypad | 11 |
| C.1.3 Display | 11 |
| C.1.4 Control unit connections/interfaces | 14 |
| C.1.5 Control unit power supply | 14 |
| C.2 Flue gas analyzer | 15 |
| C.2.1 Flue gas analyzer overview | 15 |
| C.2.2 LED status display | 16 |
| C.2.3 Flue gas analyzer connections/interfaces | 16 |
| C.2.4 Flue gas analyzer power supply | 17 |
| C.2.5 Functions/instrument options | 17 |
| C.3 Flue gas probe | 17 |
| D. Commissioning | 18 |
| E. Operation | 19 |
| E.1 Mains unit, batteries/rechargeable batteries | 19 |
| E.1.1 Changing batteries | 19 |
| E.1.2 Charging batteries | 20 |
| E.1.3 Mains operation | 21 |
| E.1.4 Direct voltage input | 21 |
| E.2 Probes/sensors | 22 |
| E.2.1 Connecting probes/sensors | 22 |
| E.2.2 Using the flue gas probe | 22 |
| E.3 Basic operating steps | 23 |
| E.3.1 Connecting system components | 23 |
| E.3.2 Switching the measuring system on | 24 |
| E.3.3 Calling up a function | 25 |
| E.3.4 Assigning function keys | 26 |
| E.3.5 Entering values /names | 27 |
| E.3.6 Printing data | 28 |

| | | |
|-----------|--|-----------|
| E.3.7 | Saving data | 28 |
| E.3.8 | Switching the measuring system off | 28 |
| E.4 | Setting the measuring system up | 29 |
| E.4.1 | Setting the language | 29 |
| E.4.2 | Setting the date/time | 29 |
| E.4.3 | Setting fuel | 29 |
| E.4.4 | Editing display | 30 |
| E.4.5 | Setting locations | 31 |
| E.4.6 | Changing the instrument name | 32 |
| E.4.7 | Setting up printer | 32 |
| E.5 | Regular care | 33 |
| E.5.1 | Condensate trap/ Condensate container | 33 |
| E.5.2 | Checking/replacing the particle filter | 34 |
| E.5.3 | Checking for system leaks | 34 |
| F. | Main menu | 35 |
| F.1 | Memory | 35 |
| F.1.1 | Read out | 35 |
| F.1.2 | Program | 35 |
| F.1.3 | Deleting memory | 37 |
| F.1.4 | Free memory? | 37 |
| F.2 | Sensors | 37 |
| F.2.1 | Recal. | 37 |
| F.2.2 | Printing sensor data | 40 |
| F.2.3 | Sensor status | 40 |
| F.3 | Input | 40 |
| F.3.1 | Spot number/HCT | 40 |
| F.3.2 | Fuel | 41 |
| F.3.3 | O2ref/CO2max | 41 |
| F.3.4 | Parameter | 41 |
| F.3.5 | Dilution | 42 |
| F.3.6 | Dew point/ambient air | 42 |
| F.4 | Device | 43 |
| F.4.1 | Change date | 43 |
| F.4.2 | View | 43 |
| F.4.3 | Printer | 43 |
| F.4.4 | Diagnostic | 44 |
| F.4.5 | Configuration | 44 |
| F.4.6 | Password | 44 |
| F.5 | Service | 45 |
| F.5.1 | Operation values | 45 |
| F.5.2 | Switch-off | 45 |
| F.5.3 | Address | 45 |
| F.5.4 | Device data | 45 |



6 Content

| | | | |
|-----------|--------------------------------------|--|-----------|
| | F.5.5 | Language | 46 |
| | F.5.6 | Bus Address | 46 |
| G. | Measuring | | 47 |
| | G.1 | Preparing measurements | 47 |
| | G.2 | Flue gas measurement | 48 |
| | G.3 | Draught/differential pressure measurement | 48 |
| | G.4 | Velocity measurement | 49 |
| | G.5 | Differential temperature measurement | 50 |
| | G.6 | Measurement program/solid fuel measurement | 50 |
| H. | Care and maintenance | | 51 |
| | H.1 | Cleaning the measuring instrument | 51 |
| | H.2 | Changing/retrofitting measuring cells | 51 |
| | H.3 | Recalibrating measuring cells | 52 |
| | H.4 | Cleaning the flue gas probe | 53 |
| | H.5 | Replacing probe preliminary filter | 53 |
| | H.6 | Replacing thermocouple | 53 |
| | H.7 | Changing the printer paper | 54 |
| | H.8 | Changing batteries/rechargeable batteries | 54 |
| | H.9 | Changing the condensate pump | 54 |
| I. | Questions and answers | | 55 |
| J. | Technical data | | 56 |
| | J.1 | Tests and accreditations | 56 |
| | J.2 | Measuring ranges and accuracies | 58 |
| | J.3 | Other instrument data | 60 |
| | J.4 | Principles of calculation | 61 |
| | | J.4.1 Fuel parameters | 61 |
| | | J.4.2 Calculation formulae | 61 |
| | J.5 | Recommended rinsing times | 64 |
| K. | Accessories/spare parts | | 65 |

A. Safety instructions



Avoid electrical hazards:

- ▶ Never use the measuring instrument and probes to measure on or near live parts!



Protect the measuring instrument:

- ▶ Never store the measuring instrument/measuring cells together with solvents (e.g. acetone). Do not use any desiccants.



For products with **Bluetooth®** (Option)

Changes or modifications, which are not expressly approved by the responsible official body, can lead to a withdrawal of operating permission.

The instruments may **not** be switched on during a flight. For this reason, the following points must be checked before entering an airport:

- ▶ No programs which automatically start at a pre-determined time may be installed (see flue gas analyzer)
- ▶ Switch off instruments (Control Unit and flue gas analyzer.)
- ▶ Disconnect Control Unit and flue gas analyzer from all external voltage supplies. (mains cable, external batteries, ...)
- ▶ All 3 control lamps on the flue gas analyzer must be off.
- ▶ The display of the control unit must be switched off.



Product safety/preserving warranty claims:

- ▶ Operate the measuring instrument only within the parameters specified in the technical data.
- ▶ Handle the measuring instrument properly and according to its intended purpose only.
- ▶ Never apply force!
- ▶ Temperatures given on probes/sensors relate only to the measuring range of the sensors. Do not expose handles and feed lines to any temperatures in excess of 70 °C unless they are expressly permitted for higher temperatures.
- ▶ Open the measuring instrument only when this is expressly described in the instruction manual for maintenance purposes.

8 A. Safety instructions

- ▶ Carry out only the maintenance and repair work that is described in the instruction manual. Follow the prescribed steps exactly. For safety reasons, use only original spare parts from Testo.

Any additional work must only be carried out by authorised personnel. Testo will otherwise refuse to accept responsibility for the proper functioning of the measuring instrument after repair and for the validity of certifications.



Ensure correct disposal:

- ▶ Dispose of defective rechargeable batteries and spent batteries at the provided collection points.
- ▶ Send the measuring instrument directly to us at the end of its useful life. We will ensure that it is disposed of in an environmentally friendly manner.

B. Intended purpose

This chapter describes the areas of application for which the measuring instrument is intended.

The testo 350-S is a portable measuring system for professional flue gas analysis. The measuring system comprises the control unit and the flue gas analyzer (measuring instrument). The testo 350-S was designed for the following tasks/applications:

- Servicing/configuration of industrial combustion plants (process systems, power stations)
- Emissions checking and verification of compliance with emissions guidelines during the servicing/assembly of burners/boilers in the industrial sector
- Measurements on gas turbines/engines of all kinds

The testo 350-S must not be used:

- for continuous measurements
- as a safety (alarm) device

The Bluetooth® option may be operated in the combination Control Unit testo 350-S and flue gas analyzer testo 350-S / -XL only in countries in which Bluetooth® is permitted (see Technical Data).

C. Product description

This chapter provides an overview of the individual components of the product.

C.1 Control Unit

The control unit is used to control, read from and program the flue gas analyzer.

C.1.1 Control unit overview



- ① Printer
- ② Display
- ③ Keypad
- ④ Interfaces: PC (RS232), Testo data bus (data)
- ⑤ Battery compartment (on rear)
- ⑥ Contact strips for connecting to the flue gas analyzer (on rear)
- ⑦ Magnetic holders (on rear)



Strong magnets

Damage to other devices!

- ▶ Keep a safe distance from products which could be damaged by magnetism (e.g. monitors, computers, pacemakers, credit cards).

C.1.2 Keypad

| Key | Functions |
|-----|---|
| | Function key (4x): Call up instrument functions or control measurement; the relevant function is shown on the display in the function bar (see <i>Display</i> , section <i>Function bar</i> , below) |
| | Switch the measuring instrument on/off. |
| | "Readings" view is open: Open the main menu. "Select function" or "Enter value/name" view is open: back to the "Readings" view. |
| | Abort selected processes or a selection or leave submenus. The main menu can always be reached by scrolling back one menu window at a time. |
| | Switch display light on/off or start the automatic timer. |
| | "Readings" view is open: Open system configuration. "Select function" or "Enter value/name" view is open: Confirm a selection/input. |
| | Scroll up/down, select a function, increase/reduce a value. |
| | Select function: The function keys may also be assigned further functions in addition to the 4 functions displayed in the function bar. If this is the case, small arrows appear above the function bar in the display. |

C.1.3 Display

The display will show different content according to the view that is active at the time.

Status line (active in all views)

The status line displays the selected function or status information:

①

① Activated function

-or-

② Instrument status:

② ③ ④ ⑤

| Symbol | Meaning |
|-------------|---|
| ! flashes | Error present that has not yet been rectified |
| | Battery warning |
| | Measurement program is active |
| | Measurement program running |
| | CO dilution is active, dilution factor 2x to 40x |
| | Dilution overall (x5) is active |
| | Searching for connected system components |
| | Flue gas measurement running |
| alternating | |

③ Activated location

④ Device address (bus address) of the activated instrument

⑤ Displayed page/total number of pages, scroll between the pages: / .

Function bar (active in all views)

The function bar shows the function that is assigned to the individual function keys at the time. The assignment of the function keys can change according to the menu.

The function keys can be configured with the following functions:

| Function | Description |
|----------|--|
| ▲ / ▼ | Scroll up/down, select a function, increase/reduce a value. Same function as for the keys ▲/▼. |
| ESC | Abort selected processes or a selection or leave submenus. The main menu can always be reached by scrolling back one menu window at a time. Same function as for the key ESC . |
| OK | "Readings" view is open: Open system configuration. "Select function" or "Enter value/name" view is open: Confirm a selection/input. Same function as for the key OK . |
| Curr. | Accept the currently highlighted value. |
| Change | Edit the setting |
| Test | Start a test printout. |
| End | Accept settings and end the function. |
| ⇄ | Switch between upper-case and lower-case text |
| ← | Delete a character in front of the cursor. |
| ␣ | Insert a space. |
| Info | Display an overview of the settings. |
| 🏠 | Reset value to the factory setting. |
| ➡ | Add the actual measured/calculated value as an input value. |
| ⏪ / ⏩ | When entering the date/time: select individual numbers. |

Additional functions can be assigned individually, see *Assigning function keys*, p. 26.

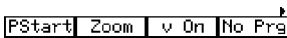

If an arrow appears above the function bar, it means that the **◀**/**▶** keys can be used to call up further functions to which a function key was assigned.

View: Readings

The measurement view displays the readings and the relevant parameters and units of measurement:

| | | | |
|--------------|-----------|-------------|--------|
| Location01 | | 005 01/04 | |
| 4.5 | 94 | 26 | |
| O2 | % NOx | ppm SO2 | ppm |
| 228.9 | 8 | 1.22 | |
| AT | °C CO | ppm PUMP | l/m |
| PStart | Zoom | v On | No Prj |

- ① Reading
- ② Parameter
- ③ Unit of measurement

6 or 3 readings are displayed on each page (this can be set using the **Zoom** function key).

View: Select function

| | | | | | | | |
|----------------|--|-----------------|--------|-------|-----------------|----------------|--|
| ① | Change Device settings | | | | | | |
| ② | <table border="1"> <tr> <td>Memory Sensors</td> <td rowspan="3">phase:</td> </tr> <tr> <td>Input</td> <td>lining time: 41</td> </tr> <tr> <td>Device Service</td> <td></td> </tr> </table> | Memory Sensors | phase: | Input | lining time: 41 | Device Service | |
| Memory Sensors | phase: | | | | | | |
| Input | | lining time: 41 | | | | | |
| Device Service | | | | | | | |
| | FT: 24.1°C | | | | | | |
| | ESC OK | | | | | | |

- ① Selected function
- ② Available functions; the one currently selected has a black background

View: Enter values

| | | | |
|---|----------------------|-------|-------|
| ① | Humidity/ambient air | | |
| ② | 0.0 | 80.0 | 100.0 |
| | Min | | Max |
| ③ | 1 | 2 | 3 |
| | 4 | 5 | 6 |
| | 7 | 8 | 9 |
| | . | 0 | ± |
| ④ | ⌫ × | | |
| ⑤ | ← | Curr. | End |

- ① Selected function
- ② Minimum/current stored/maximum value that can be entered
- ③ Input matrix for selecting the desired numbers; the selected number has a black background
- ④ Input value
- ⑤ Function bar

View: Enter name

| | | | | | | | | | | | |
|---|----------|---|---|-----|---|---|---|---|---|---|---|
| ① | Footnote | | | | | | | | | | |
| | 1 | 2 | 3 | 4 | 5 | 6 | 7 | 8 | 9 | 0 | @ |
| | q | w | e | r | t | y | u | i | o | p | |
| ② | a | s | d | f | g | h | j | k | l | + | |
| | z | x | c | v | b | n | m | . | . | - | |
| ③ | testo_ | | | | | | | | | | |
| ④ | ↩ | ← | ↵ | End | | | | | | | |

- ① Selected function
- ② Input matrix for selecting the desired symbols (letters/numbers/special characters); the selected symbol has a black background
- ③ Display of the entered name
- ④ Function bar

C.1.4 Control unit connections/interfaces



- ① RS232: PC interface
- ② Data: Interface to system components (Testo data bus)
- ③ Contact strips (on rear): Connection to the flue gas analyzer (Testo data bus)

C.1.5 Control unit power supply

! Ordinary or rechargeable batteries must always be inserted in the control unit as otherwise no connection can be established with other system components and the date/time setting will be lost.

The batteries/rechargeable batteries in the control unit are only there to power the clock and establish a connection to the flue gas analyzer. The control unit cannot function if it is not connected to a flue gas analyzer. It will then switch itself off after 15s.

Power is supplied by 4 rechargeable batteries/batteries (1.5 V, mignon, type AA).

C.2 Flue gas analyzer

The readings are taken with the help of the flue gas analyzer.

C.2.1 Flue gas analyzer overview

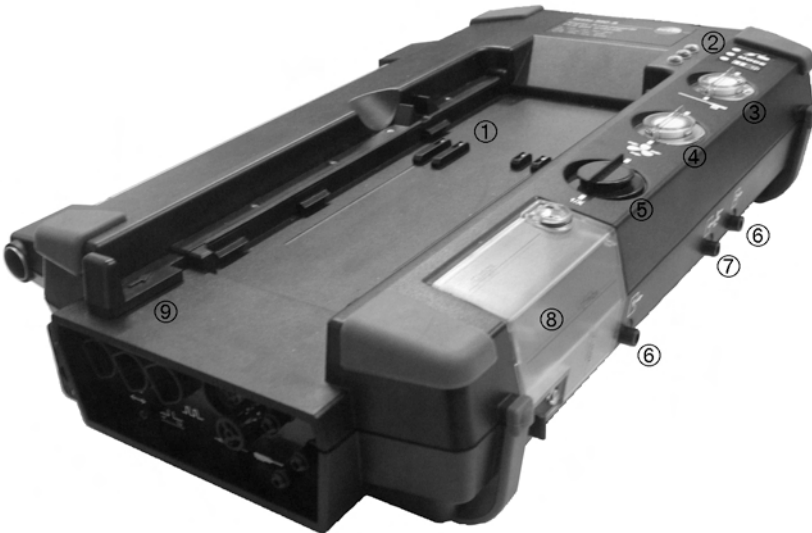

- ① Contact strips for connection to the control unit
- ② Status LEDs
- ③ Particle filter
- ④ Fresh air inlet filter (fresh air valve option, dilution **overall (x5)** function)
- ⑤ CO dilution air filter (CO measuring range extension option)
- ⑥ Gas outlet 1+2
- ⑦ Fresh air inlet
- ⑧ Condensate trap or condensate container (see *Condensate trap /Condensate container*, p. 33)
- ⑨ Unlocking lever for contact strips

C.2.2 LED status display



The status LEDs indicate the device status of the flue gas analyzer:

| Status | Display |
|--|----------------|
| Power supply (LED ①): | |
| Mains operation | green/steady |
| Rechargeable battery operation (battery fully charged) | green/flashing |
| Rechargeable battery operation (battery low) | red/flashing |
| Battery recharging, instrument switched off | off |
| Mode (LED ②): | |
| Measurement | green/steady |
| Fresh air/zeroing | green/flashing |
| Error | red/flashing |
| Battery recharging (LED ③): | |
| Recharging battery (rapid charge) | green/flashing |
| Battery fully charged, trickle charge | green/steady |

C.2.3 Flue gas analyzer connections/interfaces

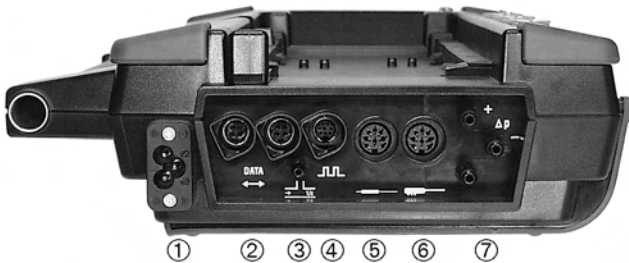



- ① Mains supply socket (110/230 V 50/60 Hz)
- ② Data: Interfaces to system components (Testo data bus)
- ③ Dilution air inlet (CO measuring range extension option)
- ④ Trigger/alarm: Interface for trigger/alarm signal
- ⑤ Ambient air temperature (**AmbT**)/temperature **T2** probe connection
- ⑥ Flue gas temperature (**FT**)/temperature **T1** probe connection
- ⑦ Gas connections (e.g. flue gas probe, Pitot tube)

C.2.4 Flue gas analyzer power supply

The flue gas analyzer is powered optionally by the integrated mains unit or by the testo rechargeable battery pack (0554 1098).

C.2.5 Functions/instrument options

Some functions are available as optional extras. The functions that your flue gas analyzer has (condition on delivery) can be read on the identification plate on the underside of the device.

| Symbol | Function |
|--|--|
| CO, NO, NO2, SO2, NO_low, CO_low, CxHy/HC, H2S, O2, CO2-IR | Measuring cell of the corresponding type is connected |
| CO-1/x | Measuring range extension, gas dilution for measuring high CO values |
|  | Fresh air valve, gas dilution (overall (x5)) for measuring high flue gas values |
| GP | Gas preparation, for greater accuracy through reduced and constant measuring gas dew point temperature |
|  | Trigger input for controlling the start/stop of measurement programs |
| Contains FCC ID:PI401B IC ID:1931B-BISMII | Bluetooth® |

C.3 Flue gas probe



- ① Probe handle with connections for probe shaft and gas tubes/thermocouple line
- ② Probe shaft
- ③ Thermocouple connector (for measuring flue gas temperature)
- ④ Connector for gas tubes

D. Commissioning

This chapter describes the steps required to commission the product.

Control Unit:

- ▶ Remove the protective film from the display.

! There must always be batteries or rechargeable batteries in the control unit as otherwise it will not be possible to establish a connection to other system components.

- 1 Open the battery compartment on the rear of the control unit (clip lock).
- 2 Insert batteries/rechargeable batteries (4x mignon, type AA). **Observe the polarity!**
- 3 Close the battery compartment.

Flue gas analyzer:

The flue gas analyzer is supplied with a rechargeable battery pack (05541098) already inserted.

- ▶ Charge the battery up fully before using the flue gas analyzer (see [Charging batteries](#), p. 20).
- ▶ To power the flue gas analyzer using the integrated mains unit, connect the mains lead to the mains connection socket.

E. Operation

This chapter describes the steps that have to be executed frequently when configuring the measuring system or using the product.

! Please read this chapter carefully. This chapter explains the basic operating concepts of the measuring instrument. The following chapters of this document will assume you are already familiar with the contents.

E.1 Mains unit, batteries/rechargeable batteries

! If the power supply to the control unit is interrupted for a long time (e.g. batteries/rechargeable batteries low), the date/time setting will be lost. The measuring system cannot be started if the batteries/rechargeable batteries are low.

E.1.1 Changing batteries

Control Unit

! The Control Unit must be switched off. Change the batteries within 1 minute in order to ensure that the Date/Time setting is not lost.

- 1 Open battery compartment on the rear of the Control Unit (clip fastening).
- 2 Remove batteries or battery pack.
For battery pack: Disconnect plug connection.
- 3 For battery pack (0515 0097): Connect plug connection.
Insert batteries (4 x Mignon, Type AA) or battery pack

! For battery pack: Note marking on plug. Do not kink or crush wiring!
For batteries: **Observe polarity!**

- 4 Close battery compartment.

Flue gas analyzer

! The flue gas analyzer must not be connected to a mains socket. The flue gas analyzer must be switched off.



- 1 Open the battery compartment on the rear of the flue gas analyzer (2 clip locks, ①).
 - 2 Remove the rechargeable battery pack from the battery compartment and disconnect the connector ②.
- !** Use only Testo rechargeable battery pack 0515 0098. When inserting the rechargeable battery pack, make sure that the leads do not get kinked or squashed.
- 3 Connect the connector of the new rechargeable battery pack in the battery compartment and insert the rechargeable battery pack into the compartment.
 - 4 Close the battery compartment.

E.1.2 Charging batteries

Control Unit

Charging batteries in the Control Unit is possible from Version 2.10.

Flue gas analyzer

The rechargeable battery pack should only be charged at an ambient temperature of $\pm 10 \dots +25$ °C. If the rechargeable battery pack has discharged completely, the charging time at room temperature is approx. 4-5 hours.

- !** The flue gas analyzer must be switched off. It is not possible to charge the rechargeable battery pack during operation.
- ▶ Connect the mains cable to the flue gas analyzer and a mains socket.
 - The charging process will start automatically. The charge status is indicated on the "Battery charging" LED:

| Status | Display |
|---------------------------------------|----------------|
| Recharging battery (rapid charge) | green/flashing |
| Battery fully charged, trickle charge | green/steady |

- The fan of the flue gas analyzer can run during the charging process.

Rechargeable battery care

- ▶ Do not totally discharge the rechargeable battery pack. When the battery warning symbol (⏻) lights up, charge the battery pack as soon as possible.
- ▶ Store the battery only charged and at low temperatures, however not below 0 °C. During longer breaks in operation, discharge and recharge the battery every 3-4 months. Conservation charging not longer than 2 days.

E.1.3 Mains operation

- ▶ Connect the mains cable to the flue gas analyzer and a mains socket.
- The flue gas analyzer is powered via the mains unit.
- If the flue gas analyzer is switched off and a rechargeable battery pack is inserted, the charging process will start automatically. Battery charging stops when the measuring system is switched on using the control unit.

E.1.4 Direct voltage input

The flue gas analyzer can additionally be supplied via an external direct voltage source (11 to 40 V DC).

For the connection,

- Cable with adapter for the cigarette lighter and adapter for connection to the flue gas analyzer (order no. 0554 1336)
- Cable with battery terminals and adapter for connection to the flue gas analyzer (order no. 0554 1337) are available.

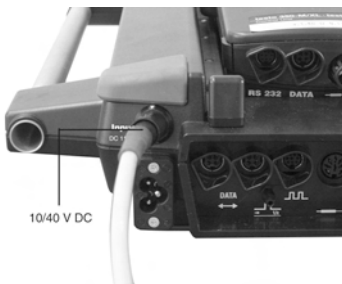

If the flue gas analyzer is switched off, the internal rechargeable battery of the instrument can be charged using an external direct voltage source (11 to 40 V DC).

E.2 Probes/sensors

E.2.1 Connecting probes/sensors

! Probe detection is carried out during the activation process: Probes that are required must always be connected before the measuring instrument is switched on, or the measuring system must be switched off and then on again after a change of probe so that the correct data can be read.

- ▶ Connect the required probes/sensors to the corresponding connections.

E.2.2 Using the flue gas probe

Checking the thermocouple



The thermocouple of the flue gas probe must not lie against the probe cage.

- ▶ Check before use. Bend the thermocouple back if necessary.

Aligning the flue gas probe



The flue gas must be able to flow freely past the thermocouple.

- ▶ Align the probe by turning it as required.

The tip of the probe must be in the centre of the flue gas flow.

- ▶ Align the flue gas probe in the flue gas duct so that the tip is in the centre of the flow (area of the highest flue gas temperature).

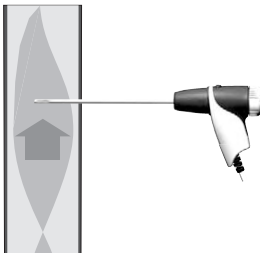

E.3 Basic operating steps

E.3.1 Connecting system components

! Only a flue gas analyzer can be connected to the testo 350-S control unit. The testo 350-M/XL control unit is required if several system components are to be connected in parallel.

Connection using contact strips

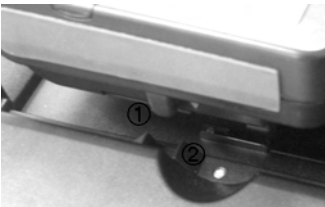

- 1 Place the control unit on the flue gas analyzer so that the guide nose on the left side of the control unit (①) is above the guide groove of the flue gas analyzer (②).
- 2 Press the control unit against the flue gas analyzer until you hear it engage.

Connection using a data bus cable (accessory part)

- ! Use only Testo data bus cables . Do not lay data bus cables near power cables.
- ! The data bus cable may not be disconnected under load
 - ▶ Connect the data bus cable to the **Data** sockets of the control unit and flue gas analyzer.

Connection via Bluetooth®

During first commissioning or if a connection to the standard analyzer is not possible, the Control Unit searches for flue gas analysers in the vicinity.

- A flue gas analyzer has been found:
Flue gas analyzer and Control Unit are automatically connected, analyzer becomes standard
- Several flue gas analyzers have been found:
The flue gas analyzers found are displayed for selection
- No flue gas analyzer found:
Error display

! If a CAN connection exists, and the Bluetooth® standard instrument is not the one currently connected, the vicinity will be searched.

! For operation without mains connection, the Control Unit must be docked onto the analyzer in order to switch on the unit. The control unit can then be removed.

Switching to Bluetooth®

- The unit automatically switches to Bluetooth® as soon as the Control Unit is separated

from the analyzer. An hourglass is shown during switchover. On completion, the display goes out and an audible signal sounds.

- Switching over to a different analyzer during Bluetooth® operation.
- ▶ Call up flue gas analyzer list and press function button **Search**.
- All analyzers are displayed.
- ▶ Select desired instrument.
- After switching off, Bluetooth® remains switched on in analyzer (in mains operation only), a new connection is thus possible at any time.

E.3.2 Switching the measuring system on

! Before switching the measuring system on, check that:

- All system components are properly connected.
- All the necessary probes/sensors are connected.
- The power supply of all system components is guaranteed.

Measuring the ambient air temperature (AmbT)

If no ambient air temperature probe is connected, the temperature measured by the thermocouple of the flue gas probe during the zeroing phase is used as the ambient air temperature. All dependent parameters are calculated using this value. This method of measuring ambient air temperature is sufficient for systems dependent on ambient air. The flue gas probe should be near the intake duct of the burner during the zeroing phase - not in the flue gas duct!

If an ambient air temperature probe is connected, the ambient air temperature is measured continuously by this probe.

The flue gas probe can be in the flue gas duct even during the zeroing phase.

Zeroing phase

During the zeroing phase the measuring cells of the flue gas analyzer are zeroed. There must be no interfering gases (e.g. CO, NO) in the ambient air during zeroing!

Switching on:

- ▶ Press .
- The initialisation screen is displayed and the data bus is scanned for connected system components (this takes up to 60 s).
- The zeroing phase starts (this takes 60 s).
- Measurement view is opened.



E.3.3 Calling up a function

Functions can be called up using function keys or from a selection list.

Calling up a function using a function key

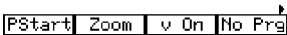
Only particular functions can be called up using a function key, see *Display*, section *Function bar*, p. 11.





If an arrow appears above the function bar, it means that the  /  keys can be used to call up further functions to which a function key was assigned.

- ▶ Press the function key that is assigned the desired function.





Calling up a function using a selection list

Selection lists appear e.g. when the main menu is called up (press  in Measurement view).

- 1 Select function: Press  or .
- The selected function is shown with a black background.
- 2 Confirm selection: Press .
- The selected function is called up.

E.3.4 Assigning function keys

The function keys that are shown on the display depend on the view that is selected. Only the function keys that can be used in the particular view are displayed.

- Measurement view is opened.
- 1 Press , release and immediately afterwards press the function key to be assigned.
 - A selection list showing the functions that can be assigned to a function key appears.
 - 2 Select the function with  or  and confirm with .

| Function | Description |
|---|--|
| PStart, PStop | Start the measuring gas pump and display readings or stop the measuring gas pump (the function key switches between the two options automatically) |
| Zoom | Zoom in (display 6 or 3 readings per page) |
| CO on, CO off | Move the CO sensor manually into the gas path or move it away manually and flush the sensor with fresh air (the function key switches between the two options automatically) |
| v On, v Off | Zero the pressure sensor and activate velocity measurement or switch off velocity measurement (the function key switches between the two options automatically) |
| Mem. | Save readings |
| DeltaT | Start 2-channel temperature measurement, displaying the differential temperature |
| DeltaP | Zero the pressure sensor and start differential pressure measurement (draught measurement) |
| Start, Stop | Start or stop the measurement program (the function key switches between the two options automatically) |
| Print | Print readings |
| LF Dr | Activate the printer line feed |
| Zero | Start the zeroing phase manually (duration: 60 s) |
| Gas, Air | Switch manually between exposing the measuring cells to measuring gas or fresh air (the function key switches between the two options automatically) |
| Diag. | Display unrectified errors |
| (leer) | The function key does not trigger any function |
| 1 x ¹⁾, auto or (5 x) | Only with CO measuring range extension or fresh air valve option: Call up the Dilution Dilution function, see <i>Dilution</i> , p. 42 |
| HC on, HC off | Only with the HC module option: Switch the HC sensor on or off (the function key switches between the two options automatically) |

E.3.5 Entering values /names

Some functions require values (figures) or a name (characters) to be entered. Inputs are made using an input editor.

Input editor for values

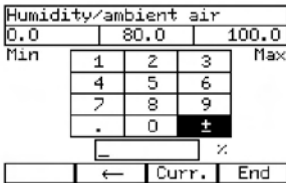

1 Select the value (character): Press **◀**, **▶**, **▲**, **▼**.

2 Accept the value: Press **OK**.

Options:

- ▶ Accept the current reading: **→**.
- ▶ Delete a character in front of the cursor: **←**.
- ▶ Accept the currently highlighted value: **Curr.**
- ▶ Select individual number (only when inputting date/time): **↓**, **↑**.

3 Repeat steps 1 and 2 as required.

4 Accept settings: Press **End**.

Input editor for names



1 Select the value (character): Press **◀**, **▶**, **▲**, **▼**.

2 Accept the value: Press **OK**.

Options:

- ▶ Switch between upper-case and lower-case letters: **⇄**.
- ▶ Delete a character in front of the cursor: **←**.
- ▶ Insert space: **␣**.

3 Repeat steps 1 and 2 as required.

4 Accept settings: Press **End**.

E.3.6 Printing data

To print readings, a function key must be assigned the **Print** function, see *Assigning function keys*, p. 26. Only those readings that were assigned a display field in the Measurement view will be printed.

► Print readings: .

The measurement data that are currently stored can be printed out while a measurement program is running.

1 Open the Main menu: Press .

2 **Memory** → → **Read out** → .

3 Select the protocol for the current measurement and confirm with .

4 Print readings: .

E.3.7 Saving data

To save readings a function key must be assigned the function **Mem.** , see *Assigning function keys*, p. 26. Only those readings that were assigned a display field in the Measurement view will be saved.

► Save readings: .

E.3.8 Switching the measuring system off

! Unsaved readings are lost when the measuring system is switched off!

Rinse phase

During the rinse phase the measuring cells of the flue gas analyzer are rinsed with fresh air. The duration of the rinse phase depends on the gas concentration in the measuring cells. The rinse phase is ended once a certain threshold value is reached.





Switching off:

► Press .







- The rinse phase starts.
- The measuring system switches itself off. It is normal for the fan of the flue gas analyzer to run on for a while.
- If the flue gas analyzer is connected to a mains socket and a rechargeable battery pack is inserted, the charging process will start automatically.

E.4 Setting the measuring system up





E.4.1 Setting the language

- Measurement view is opened.
- 1 Open the Main menu: Press .
 - 2 **Service** →  → **Language** or **Sprache** → .
 - 3 Select the language and confirm with .

E.4.2 Setting the date/time

- Measurement view is opened.
 - No measurement program is active (otherwise the function is locked).
- 1 Open the Main menu: Press .
 - 2 **Device** →  → **Change date** → .
 - 3 Select the date or time with ,  and press .
 - The input editor is opened.
 - 4 Enter values and accept settings with .

E.4.3 Setting fuel

- Measurement view is opened.
- 1 Open the Main menu: Press .
 - 2 **Input** →  → **Fuel** → .
 - 3 Select the fuel and confirm with .

E.4.4 Editing display

Only those parameters and units of measurement to which a display field was assigned in the Measurement view are displayed in the Measurement view, in the saved measurement protocols and on printouts of readings.

The assignment of parameters/units of measurement to the individual display fields in the Measurement view can be changed. The following parameters and units are available (may vary from one instrument to another):

| Display | Parameter | Units |
|---------|----------------------------------|---------------------------------------|
| O2 | Oxygen | % |
| CO | Carbon monoxide | ppm, %, g/GJ, mgm ³ , mgKW |
| NO | Nitrogen monoxide | ppm, %, g/GJ, mgm ³ , mgKW |
| SO2 | Sulphur dioxide | ppm, %, g/GJ, mgm ³ , mgKW |
| NO2 | Nitrogen dioxide | ppm, %, g/GJ, mgm ³ , mgKW |
| CxHy | Hydrocarbons | ppm, %, g/GJ, mgm ³ , mgKW |
| H2 | Hydrogen | ppm |
| NOx | Nitrogen oxides | ppm, %, g/GJ, mgm ³ , mgKW |
| FT | Flue gas temperature | °C, °F |
| AmbT | Combustion air temperature | °C, °F |
| deltaT | Differential temperature T1 - T2 | °C, °F |
| T1 | Temp. sensor connection T1 | °C, °F |
| T2 | Temp. sensor connection T2 | °C, °F |
| qA | Flue gas loss | % |
| CO2 | Carbon dioxide | % |
| Lamb | Air ratio | - |
| Eta | Efficiency | % |
| dCO | Carbon monoxide undiluted | ppm |



| Display | Parameter | Units |
|-----------------|--|---|
| SSN | Smoke number | - |
| oild | Oil derivative | - |
| HCT | Heat carrier temperature | °C, °F |
| O2rf | Oxygen reference value | % |
| CO2m | Max. carbon dioxide value | % |
| deltaP | Differential pressure | mbar, hPa, mmWS, inW |
| Drgh | Flue draught | mbar, hPa, mmWS, inW |
| Volt | Recharbeable battery voltage Flue gas analyzer | V |
| IntT | Instrument temperature | °C, °F |
| O/h | Operating hours | h |
| Pump | Pump output | l/m |
| Spd | Flow rate | m/s |
| Vol | Volumetric flow rate | m ³ /s, m ³ /m, m ³ /h, m ³ /T, m ³ /J |
| td | Flue gas dew point temperature | °C, °F |
| MCO, MSO2, MNOx | Mass flow | kg/h, kg/T, t/h, t/T, t/J |
| Fuel | Fuel | - |
| DilF | Dilution stage CO | - |
| RTim | Gas residual time until next rinse phase (measurement program) | min |

- Measurement view is opened.

1 Open the Main menu: Press .

2 **Device** → **OK** → **View** → **OK**.

- The parameter and the unit of the display fields is displayed.

3 Select the display field to be changed with , , ,  and confirm with **OK**.

Options:

▶ Insert a new display field: **Insert** → **OK**.

▶ Delete the current display field: **Delete** → **OK**.

- 4 Select the **Parameter** and confirm with **OK**.
- 5 Select the parameter that is to be assigned to the display field and confirm with **OK**.
- 6 Select the unit of measurement that is to be assigned to the parameter and confirm with **OK**.

E.4.5 Setting locations



The memory in the testo 350-S is organised in such a way that what is known as a "location" must be activated to identify a saved measurement. The default location is called **Noname**.

On saving, readings are assigned to whichever location is active at the time of saving. Several measurements can be saved for each location. It is also possible to organise locations in folders/subfolders.

The maximum possible number of measurements that can be saved depends on whether each individual measurement is saved under its own location or all measurements are stored exclusively under one location.

Unsaved readings are lost when the measuring instrument is switched off!

Creating/copying/editing/deleting a folder/location:

- Measurement view is opened.
- 1 Open location management: Press **OK**.
 - Available folders () and locations () are displayed.
 - ▶ If the folder/location is to be created in an existing folder: Select the folder and confirm with **OK**.
 - ▶ If a folder/location is to be edited, deleted or copied: Select the folder so that it is given a colour background.
 - 2 Press **Change**.
- Options:**
- ▶ To print saved measurement data records of the selected location:
Print location → **OK**.
 - ▶ To display information about the selected location: **Info** → **OK**.
- 3 Select the desired option and confirm with **OK**.
 - 4 When creating, copying or editing a folder/location: Enter the name and confirm with **End**.

Activating a location:

- Measurement view is opened.
- 1 Open location management: Press **OK**.
- Available folders (📁) and locations (📍) are displayed.
- 2 Open the Edit function: Press **Change**.
- 3 Select the desired folder or location and confirm with **OK**.
 - ▶ If a folder was selected: Repeat the process.
- Measurement view is opened.

E.4.6 Changing the instrument name

- Measurement view is opened.
- 1 Open location management: Press **OK**.
- 2 Press **▶**.
- The connected instruments are displayed.
- 3 Select the instrument and press **Change**.
- 4 Enter the name and confirm with **End**.

E.4.7 Setting up printer

The control unit must be switched off.

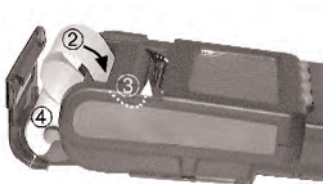

- 1 Open the paper compartment: Grip the cover by the side recesses and pull up (①).
- 2 Push the end of the paper roll, with the outside (= printable side) facing down, as far as possible into the back slot (②).
- 3 Switch on Control Unit, press: **⏻**.
- 4 During the installation phase, press **Lfdr** 12 to 13 times in order to feed the paper through (③). The paper may initially need to be pushed lightly by hand until the transport roller grips.
- 5 Place the paper roll in the paper compartment (④) and close.

E.5 Regular care

E.5.1 Condensate trap/ Condensate container

With gas preparation (**GP**, optional) fitted, the condensate is separated from the measuring gas and is led into a condensate container that is isolated from the gas path. In the case of longer measurements with moist flue gas, the condensate can be led off using a tube without any external air being carried along.

On instruments without gas preparation, the measuring gas is led through a condensate trap. This must always be kept closed during measurement so as to prevent external air being drawn in.

The fill level of the condensate trap/condensate container is indicated by the markings.

Emptying the condensate trap/condensate container

! The condensate consists of a weak mix of acids. Avoid contact with the skin. Make sure that the condensate does not run over the housing.



Condensate entering the gas path.

Damage to the measuring cells and flue gas pump!

- ▶ Do not empty the condensate trap/condensate container while the flue gas pump is in operation.

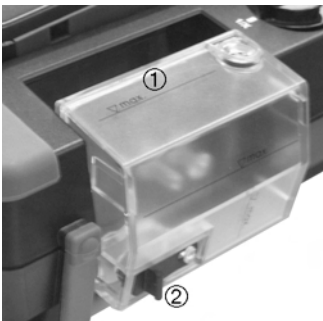

- 1 Pull the condensate trap/condensate container (①) horizontally from the flue gas analyzer.
- 2 Open the drain plug (②) and allow the condensate to drain into a sink.
- 3 Wipe off any drops still on the condensate outlet using a cloth and close the condensate outlet.
- 4 Attach the condensate trap/condensate container to the flue gas analyzer.

E.5.2 Checking/replacing the particle filter

Checking the particle filter:

Check the particle filter of the flue gas analyzer for contamination at regular intervals: Check visually by looking through the window of the filter chambers. Replace the filter if there are signs of contamination.

Replacing the particle filter:

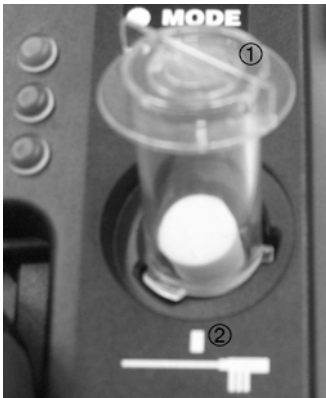

! The filter chamber may contain condensate.

- 1 Open the filter chamber: Turn the filter cover (①) anticlockwise and remove.
- 2 Remove the spent filter and replace it with a new one (0554 3381).
- 3 Attach the filter cover and lock by turning it clockwise. The cross part of the filter cover must be aligned with the markings on the housing (②).

E.5.3 Checking for system leaks

Check the measuring system for leaks at regular intervals. This will help to ensure accurate measurement.

The leak test requires a plastic cap (0193 0039, comes with the flue gas probe). The instrument must be switched on. A function key must be assigned the function **Pstart** (start measuring gas pump), see [Assigning function keys](#), p. 26. A display field of the Measurement view must be assigned the parameter **Pump** (flue gas pump volumetric flow rate), see [Editing display](#), p.30.

- Measurement view is opened.

1 Place the plastic cap on the tip of the flue gas probe so that the openings are completely covered.

2 Press **Pstart**.

- Volumetric flow rate less than or equal to 0.1 l/min: measuring system is not leaking.

-or-

- Volumetric flow rate greater than 0.1 l/min: measuring system is leaking.

- ▶ Check the probe and flue gas analyzer for leaks.

F. Main menu

This chapter describes the functions available in the main menu.

! Familiarity with the contents of the chapter *Operation* (see p. 19) is assumed.

F.1 Memory

F.1.1 Read out

Viewing/printing saved measurement data:

1  → **Memory** → **OK**.

2 **Read out** → **OK**.

3 Select the measurement data record.

Option:

▶ View the properties of the measurement data record: **Info**, return with **ESC**.

4 Confirm with **OK**.

Option:

▶ Print a measurement data record: **Print**.

F.1.2 Program

The **solid fuel measurement** program is only available with instruments equipped with the measurement range extension CO option of a CO measurement cell (not CO_{low}) and gas preparation. The measurement program **solid fuel measurement** cannot be altered.

The **Trigger** function (trigger signal as the start/end criterion) is only available on instruments with the trigger input option.

Instrument settings cannot be changed if a program is active or running.

Saving (= activating) a measurement program/solid fuel measurement:

- 1  → **Memory** → **OK**.
 - 2 **Program** → **OK**.
 - 3 Select the measurement program and confirm with **OK**.
 - 4 Select **Save** and confirm with **OK**.
- The measurement program is activated.

Deleting (= deactivating) a measurement program/solid fuel measurement:

- 1  → **Memory** → **OK**.
 - 2 **Program** → **OK**.
 - 3 Select the measurement program and confirm with **OK**.
 - 4 **Delete** → **OK**.
- The measurement program is deactivated (not deleted!).

Viewing the properties of the measurement program/solid fuel measurement:

- 1  → **Memory** → **OK**.
 - 2 **Program** → **OK**.
 - 3 Select the measurement program.
 - 4 Press
- or-
- OK** → **Info** → **OK**.
- The properties of the selected measurement program/solid fuel measurement are displayed.
- 5 To leave the function without activating a program/solid fuel measurement: .
 - To leave the function and activate a program/solid fuel measurement: **OK**.

Editing a measurement program:

- 1  → **Memory** → **OK**.
- 2 **Program** → **OK**.
- 3 Select the measurement program and confirm with **OK**.
- 4 Select the first parameter for defining the measurement program and confirm with **OK**.
- 5 Enter the properties/values and confirm.
- 6 Repeat the process for other parameters.

F.1.3 Deleting memory

Clearing the whole memory (folders, locations and measurement data):

- 1  → **Memory** → **OK**.
- 2 **Delete memory** → **OK**.
- 3 **No** → **OK**: Cancel the function.
-or-
Yes → **OK**: Clear the memory.

F.1.4 Free memory?

Viewing free memory space:

- 1  → **Memory** → **OK**.
- 2 **T_FREE memory?** → **OK**.

F.2 Sensors

F.2.1 Recal.

CO, SO₂, NO₂, NO and O₂ measuring cells can be tested and recalibrated; CO₂(IR) measuring cells can be recalibrated. A recalibration of O₂ only lasts until zeroing is performed. Calibration data are stored in the measuring cell, not in the instrument!

If obviously unrealistic readings are displayed, the measuring cells should be checked and recalibrated as required. To ensure that specific accuracies are retained, Testo recommends testing every six months and recalibration when required.



Dangerous gases

Danger of poisoning!

- ▶ Observe safety regulations/accident prevention regulations when handling test gases.
 - ▶ Use test gases in well ventilated rooms only.
-

- ! Recalibration with low gas concentrations can lead to deviations in accuracy in the upper measuring ranges.
Sensor protection (**Switch-off** function) is not deactivated in recalibration. The test gas concentration should therefore be lower than the set thresholds for the sensor protection.
The dilution function **overall (x5)** is automatically deactivated in recalibration.
If the instrument is fitted with an HC measuring cell, this should be switched off before test gas is applied.

The following conditions must be met when recalibrating:

- Use absorption-free tube material
- Switch the measuring instrument on at least 20 min before recalibration (warming-up)
- Use clean air for gas zeroing
- Charge the test gas via calibration adapter (0554 1205, recommended) or the tip of the probe
- Maximum overpressure of the test gas: 30 hPa (recommended: unpressurised via bypass)
- Charge the test gas for at least 3 min







Recommended test gas concentrations and compositions are given in Testo's field guide to test gases.

The recalibration function can be protected by means of a password. The password may be customised, see *Parameter*, p. 41.

Performing CO₂(IR) recalibration:

Zero point calibration must be performed before CO₂(IR) is recalibrated. Gradient adjustment (2nd calibration point) can be carried out subsequently if necessary.

Zero point calibration requires a test gas of 0 % CO₂ or a CO₂ filter (absorption filter). If using a CO₂ filter, please follow the corresponding instructions for use.

- 1  → **Sensors** → .
- 2 **Recal.** → .
- 3 If password protection is activated: Enter the password → .
- 4 **CO₂i** → .
- 5 Connect the CO₂ filter or apply test gas (0 % CO) and confirm with .
- A rinse phase is started.
- 6 When the rinse phase is over start zero point calibration with .
- Once a stable actual value is reached, the zero point is automatically calibrated.

- 7 Repeat zero point calibration: **Zeropoint calibr.** → **OK**.
-or-
End the function: **ESC**
-or-
Perform gradient adjustment: **Gradient** → **OK**.
- 8 Enter the test gas concentration (nominal value) → **Start**.
- 9 Start gradient adjustment with **Start**.
- Once a stable actual value is reached, the gradient is automatically calibrated.
A test gas check can be carried out to check the recalibration:
- 10 End the function without carrying out a check: **ESC**
-or-
Carry out a check: **OK**.
- 11 Enter the test gas concentration (nominal value) (or a different concentration as in recalibration) → **Start**.
- Once a stable actual value is reached, the result of the test gas check is displayed.
- 12 Save the nominal value/actual value and date/time of the test without calibrating the sensor and end the function: **Mem.**

Testing/recalibrating CO/SO₂/NO₂/NO/O₂ measuring cells:

- 1  → **Sensors** → **OK**.
- 2 **Recal.** → **OK**.
- 3 If password protection is activated: Enter the password → **End**.
- 4 Select the sensor → **OK**.
- 5 Enter the test gas concentration (nominal value) → **End**.
- 6 Charge the sensor with test gas and wait until the actual value is stable.
- 7 Save the nominal value/actual value and date/time of the test without calibrating the sensor and end the function: **Mem.**
-or-
Calibrate the sensor: **OK**.
A test gas check can be carried out to check the recalibration:
- 8 End the function without carrying out a check: **ESC**
-or-
Carry out a check: **OK**.
- 9 Enter the test gas concentration (nominal value) (or a different concentration as in recalibration) → **End**.

10 Charge the sensor with test gas and wait until the actual value is stable.

11 Save the nominal value/actual value and date/time of the test without calibrating the sensor and end the function: .

F.2.2 Printing sensor data

Printing saved sensor data:

1  → **Sensors** → .

2 **Print cal. data** → .

F.2.3 Sensor status

Viewing the calibration date and sensitivity of the sensors:

1  → **Sensors** → .

2 **sensor status** → .

F.3 Input

F.3.1 Spot number/HCT

The **Spot number/HCT** function is only available if it is displayed, see *Configuration*, p.44.

Entering smoke numbers/heat carrier temperature and oil derivative:

1  → **Input** → .

2 **Spot number/HCT** → .

3 **Smoke number 1** → .

4 Enter the value → .

5 Repeat step 4 for **Smoke number 2**, **Smoke number 3** and **Heat carrier temp.** .

6 Select oil derivative **No** or **Yes** → .

- An overview of the entered values is displayed.

F.3.2 Fuel

Selecting fuel:

- 1  → Input → **OK**.
- 2 Fuel → **OK**.
- 3 Select the fuel → **OK**.

F.3.3 O2ref/CO2max

The O₂ reference value and the max. CO₂ concentration are fuel-specific coefficients. The input values always refer to the fuel that is set at the time.

The O₂ref/CO₂max function can be protected by means of a password. The password may be customised, see *Parameter*, on this page.

Entering the O₂ reference value/max. CO₂ concentration:

- 1  → Input → **OK**.
- 2 O₂ref/CO₂max → **OK**.
- 3 If password protection is activated: Enter the password → .
- 4 Select **O₂ref** or **CO₂max** → **OK**.
- 5 Enter the value → .





F.3.4 Parameter

Entering calculation parameters:





Some calculated variables relate to particular reference values (ambient conditions or factors for certain probes). These can be entered by means of the parameter function.

The following values can be entered for the individual parameters

| Parameter | Value input |
|----------------------|--|
| Pres. | from height: Enter the barometric pressure, metres above sea level and differential pressure Absolute: Enter the absolute pressure directly or have the absolute pressure calculated from the values of the barometric pressure, metres above sea level and differential pressure parameters with  . |
| Pitot factor | This value depends on the type of Pitot tube that is used |
| Cross section | Circle: Enter the diameter Square: Enter the side length Rectangle: Enter the side lengths a and b Area: Enter the cross-section area |
| Offset factor | This should be set at 1.00 for all standard applications |

- 1  → **Input** → .
- 2 **Parameter** → .
- 3 Select the parameter → .
- 4 Enter the value(s) → .

Viewing the settings of the calculation parameters:

- 1  → **Input** → .
- 2 **Parameter** → .
- 3 **Info** → .

F.3.5 Dilution

The CO measuring range extension (optional) and dilution **overall (x5)** (fresh air valve option) functions can be set. To enable measuring range extension for CO or dilution for all measuring cells, the measuring gas is diluted with fresh air by means of a valve. This results in a higher measuring range.

It is possible to choose various CO dilution factors between **2x** and **40x**. If the dilution stage **auto** is selected, dilution (5x) is activated automatically when the set CO shut-off threshold is reached. If **overall (5x)** is selected, all measuring cells are diluted (5x). The measurement channels O₂, CO₂(IR), HC, CO₂, qA, Lambda, Eta and all measurement channels for flow velocity measurement are blanked out when dilution overall is selected. The measuring range extension/dilution is deactivated with **1x**.

- 1  → **Input** → .
- 2 **Dilution** → .
- 3 Select the dilution factor → .

F.3.6 Dew point/ambient air

Entering ambient air parameters:

The **Temperature/ambient air**, **Humidity/ambient air** and **Dew point/ambient air** parameters influence the calculation of qA (flue gas loss), TP (flue gas dew point) and mass flows. For all standard applications the parameters should be set to the default settings (Temperature/ambient air: 20.0 °C, Humidity/ambient air: 80.0 %, Dew point/ambient air: 16.4 °C). To achieve greater accuracy, the values can be adjusted to the actual ambient conditions.

The **Dew point/ambient air** parameter can be calculated from the values of the **Temperature/ambient air** und **Humidity/ambient air** parameters. .

- 1  → **Input** → **OK**.
- 2 **Dew point/ambient air** → **OK**.
- 3 Select the parameter → **OK**.
- 4 Enter the value(s) → **End**.

F.4 Device

F.4.1 Change date

Setting the date/time:

- No measurement program is active (otherwise the function is locked).



- 1  → **Device** → **OK**.
- 2 **Change date** → **OK**.
- 3 Select the date or time → **Change**.
- 4 Enter the values → **End**.

F.4.2 View

The assignment of parameters/units of measurement to the individual display fields in the Measurement view can be changed, see [Editing display](#), p. 30.

F.4.3 Printer

Setting the contrast:

- 1  → **Device** → **OK**.
- 2 **Printer** → **OK**.
- 3 **Contrast** → **OK**.
- 4 Set the contrast with , .

Option:

- ▶ Start a test printout: **Test**.
- 5 **End**.

Entering header/footer text:

- 1  → **Device** → **OK**.
- 2 **Printer** → **OK**.
- 3 **Print text** → **OK**.
- 4 Select the line → **OK**.
- 5 Enter the text → .

F.4.4 Diagnostic

Viewing error messages:

- 1  → **Device** → **OK**.
- 2 **Diagnostic** → **OK**.

F.4.5 Configuration

The smoke number/HCT function (see *Spot number /HCT*, p. 40) can be displayed/hidden.

Displaying/hiding the smoke number/HCT function:

- 1  → **Device** → **OK**.
- 2 **Configuration** → **OK**.
- 3 **Spot number /HCT menu** → **OK**.
- 4 Select the option → **OK**.

F.4.6 Password

The recalibration, O2ref/CO2max and shut-off functions can be protected by means of a password. This function allows the password to be changed. When **0000** (default setting) is entered the password query in the specific functions is deactivated.

- ! If the password is changed, the new one must be stored at a secure location. The functions mentioned above cannot be accessed without a valid password.

Entering/changing the password:

- 1  → **Device** → **OK**.
- 2 **Password** → **OK**.
- 3 If a password has already been set: Enter the current password → .
- 4 Enter the new password → .

F.5 Service

F.5.1 Operation values

Displaying operating values:

- 1  → **Service** → **OK**.
- 2 **Op. values** → **OK**.

F.5.2 Switch-off

Threshold values can be set in order to protect the sensors against overloading. If these values are exceeded, the sensors are switched off automatically.

The switch-off function can be protected by means of a password. The password may be customised, see *Parameter*, p. 41.

Setting switch-off thresholds:

- 1  → **Service** → **OK**.
- 2 **Switch-off** → **OK**.
- 3 If password protection is activated: Enter the password → .
- 4 Select the sensor → **OK**.
- 5 Enter the threshold value → .

F.5.3 Address

Displaying the Testo service address:

- 1  → **Service** → **OK**.
- 2 **Address** → **OK**.

F.5.4 Device data

Displaying device data:

- 1  → **Service** → **OK**.
- 2 **Device data** → **OK**.

F.5.5 Language

Setting the menu language:

- 1  → **Service** → **OK**.
- 2 **Language** or **Sprache** → **OK**.
- 3 Select the language → **OK**.

F.5.6 Bus Address

To enable the system components to communicate via the Testo databus, each system component has its own bus address. Each address can be changed.

We recommend that you do not change the preset address.

Changing the bus address:

! The changed bus address will not be active until the next time the measuring system is started.

- 1  → **Service** → **OK**.
- 2 **Bus Address** → **OK**.
- 3 Enter the value → .

F.5.6.1 Bluetooth® option

When using the Bluetooth® option, the bus address is changed

- immediately when Bluetooth® connection is active
- in active CAN connection when switching to Bluetooth®

G. Measuring

This chapter describes the measuring tasks that can be carried out with the product.

! Familiarity with the contents of the chapter *Operation* (see p. 19) is assumed.

G.1 Preparing measurements

Setting the measuring system up:

- ▶ Set the fuel of the combustion plant that is to be measured, see *Setting fuel*, p. 29.
- ▶ Assign the necessary parameters and units of measurement to a display field in the Measurement view, see *Editing display*, p. 30.
- ▶ Activate the location to which the readings are to be assigned, see *Setting locations*, p. 31.

Keeping gas outlets free:

When measuring, make sure that the gas outlets of the flue gas analyzer are exposed so as to allow the gas to escape unhindered. Otherwise the measurement results may be distorted.

Measurements with the HC measuring cell:

Gases that could form an ignitable mixture when exposed to air must not be measured:



Warnung!

Dangerous mixture of gases

Danger of explosion!

- ▶ Always perform measurements in flue gas ducts.

! There must always be sufficient oxygen in the flue gas to prevent the HC measuring cell being destroyed. If the O₂ content is less than 2 %, the HC measuring cell will switch off automatically (safety function). Higher concentrations of silicones, H₂S and sulphurous hydrocarbons can also lead to the destruction of the HC measuring cell.

Zeroing takes place automatically when the HC measuring cell is activated (**HC On**). To ensure that accurate HC readings are obtained, you should then wait about 10 min (with the instrument switched on) before starting another zeroing process (**Zero**). To prevent the HC measuring cell from drifting during lengthy measurement operations, zeroing should be carried out occasionally (**Zero**).

G.2 Flue gas measurement

For a flue gas measurement to be performed, a function key must be assigned the function **PStart** (start measuring gas pump), see *Assigning function keys*, p. 26.

A multi-hole probe is used to measure **dco** (undiluted carbon monoxide).

! After measurements involving high concentrations and long durations, the instrument should be rinsed with fresh air so that the measuring cells can regenerate themselves again, see the chapter *Recommended rinsing times*, p. 64.

Measuring:

- 1 Start measuring: **PStart**.
 - The readings are displayed.
- 2 Stop measuring and record the readings: **PStop**.

G.3 Draught/differential pressure measurement

For draught/differential pressure to be measured, a function key must be assigned the function **DeltaP** (draught/differential pressure measurement), see *Assigning function keys*, p. 26.

Measuring:

! Do not measure for longer than 5 min, as a drift of the pressure sensor can result in readings outside the tolerance limits.

Do not change between rechargeable battery and mains operation during the draught/differential pressure measurement (voltage fluctuations influence the measurement result)!

If you conduct the draught/differential pressure measurement after a flue gas measurement, a head of pressure still exists in the hose after the pump has stopped. It must be dispelled. This occurs within approx. 30 seconds.

Remove any traces of condensation in the flue gas probe (shake out the probe with the tip towards the floor).

When measuring the gas flow pressure of e.g. gas heaters:



Warnung!

Dangerous mixture of gases

Danger of explosion!

- ▶ Make sure there are no leaks between the sampling point and the measuring instrument.
- ▶ Do not smoke or use naked flames during measurement.

- 1 Depressurise pressure inputs (ambient pressure).
- 2 Start the measurement: .
- The pressure sensors are zeroed.
- 3 Pressurise the pressure inputs.
- The readings are displayed.
- 4 Stop measuring: .
- If a display field is assigned the parameter **DeltaP**, the reading is copied into the Measurement view.

G.4 Velocity measurement

For a velocity measurement to be performed, a function key must be assigned the function **V On** (velocity measurement), see *Assigning function keys*, p. 26. For the readings to be displayed, a display field must be assigned the necessary velocity parameter (**Spd**, **Vol**, **MCO**, **MSO2**, **MNOx**). A temperature probe must be connected to the flue gas temperature probe input.

For correct measurement results, the parameters **Pres.**, **Pitot factor**, **Cross section** and **Dew point/ambient air** (if calculating the mass flow) must be set. Flow velocity measurement can be carried out parallel to exhaust gas measurement.

Measuring:

- ! Do not measure for longer than 5 min, as a drift of the pressure sensor can result in readings outside the tolerance limits.
- 1 Depressurise pressure inlets (ambient pressure).
 - 2 Start the measurement: .
 - The pressure sensors are zeroed.
 - 3 Pressurise pressure inlets/insert the Pitot tube into the flow duct.
 - The readings are displayed.
 - 4 Stop measuring and record the readings: .

G.5 Differential temperature measurement

In order to carry out a differential temperature measurement, a function key must be assigned the function **deltaT**, see *Assigning function keys*, p. 26.

Carrying out measurement:

- 1 Start measurement: .
- The measurement values are displayed ($T1 = FT$, $T2 = AT$, $\text{deltaT} = T1 - T2$).
- 2 End measurement and freeze readings: .

G.6 Measurement program/solid fuel measurement

The **solid fuel measurement** program is only available with instruments equipped with the measurement range extension CO option of a CO measurement cell (not CO_{low}) and gas preparation.

For a measurement program/solid fuel measurement to be performed, a function key must be assigned the function **Start** (start measurement program/solid fuel measurement), see *Assigning function keys*, p. 26.

Draught, differential pressure and velocity readings cannot be determined within one measurement program.

The measurement program/solid fuel measurement must be activated, see *Program*, p. 35.

Measuring:

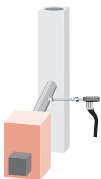

- 1 Insert flue gas probe (with probe pre-filter) into the flue gas pipe and position in the core flow
- 2 Start pump
- Observe measurement values until the $O_2 < 20\%$, in order for values to be calculated
- 3 Start measurement program / solid fuel measurement:
(without flushing phase).
- The measurement program/solid fuel measurement runs until the set end criterion (15 min/ 900 measurement values) has been reached. This is always followed by a rinse phase (duration: 2 min).

- The measurement program/solid fuel measurement remains active even after the program has come to an end.
 - ▶ Deactivate the measurement program/solid fuel measurement, see *Program*, p. 35.

H. Care and maintenance

This chapter describes the steps and action required in order to keep the product functioning properly.

See also *Regular care*, p. 33.

H.1 Cleaning the measuring instrument

- ▶ If the housing of the measuring instrument is dirty, clean it with a damp cloth. Do not use any aggressive cleaning agents or solvents! Weak household cleaning agents and soap suds may be used.

H.2 Changing/retrofitting measuring cells

A slot bridge (0192 1552) must be inserted in slots which are not occupied by a measuring cell. Used measuring cells must be disposed of as special waste!

The CO₂(IR) measuring cell can only be changed/retrofitted by a Testo service centre.

The flue gas analyzer must be switched off and isolated from the mains supply.

- 1 Place the flue gas analyzer on its front.
- 2 Open the cover of the measuring cell compartment (clip lock) and remove.
- 3 If applicable: pull the measuring cell heater from the faulty measuring cell.
- 4 Pull tube connections from the connecting nipples of the faulty measuring cell/bridge and remove the faulty measuring cell/bridge from the slot.

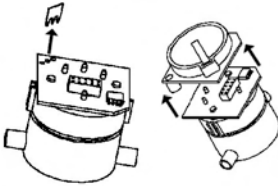

- ! Do not remove shorting jumpers/auxiliary circuit boards of the new measuring cells until immediately before installation. Do not leave the measuring cells without a shorting jumper/auxiliary circuit boards for longer than 15 min.
- ▶ CO, CO_{low}, NO₂, SO₂, H₂S measuring cell:
Remove the shorting jumpers.
- ▶ NO/NO_{low} measuring cell:
Remove the auxiliary circuit board.

Measuring cells must be connected at the slots provided for that purpose. These are marked accordingly.

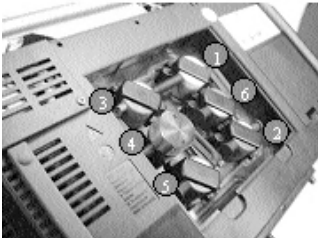

| Position | Measuring cell |
|----------|--|
| 1 | O ₂ |
| 2 | CO/H ₂ , CO _{low} /H ₂ |
| 3 | NO, NO _{low} |
| 4 | NO ₂ , SO ₂ , H ₂ S, CO ₂ (IR)yp |
| 5 | NO ₂ , SO ₂ , H ₂ S, |
| 6 | NO ₂ , SO ₂ , H ₂ S, HC |

- 5 Insert a new measuring cell/bridge in the slot.
 - 6 If applicable: connect the measuring cell heater to the measuring cell.
 - 7 Attach tube connections to the connecting nipples of the measuring cell/bridge.
 - 8 Replace the cover of the measuring cell compartment and close.
- ! After replacing an O₂ measuring cell, wait for an equalisation period of 60 min to elapse before using the instrument again.
After installation (connection to the supply voltage), an NO measuring cell needs about 2 h before it is operational.

H.3 Recalibrating measuring cells

See Sensors, p. 37.

H.4 Cleaning the flue gas probe

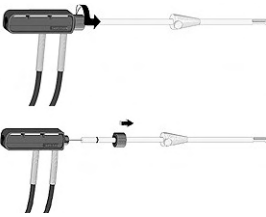

! Detach the flue gas probe from the measuring instrument before cleaning.

- 1 Loosen the threaded ring of the probe shaft from the probe handle by turning it anticlockwise and pull off the probe shaft.
 - ▶ Probe shafts with preliminary filter: unscrew the preliminary filter.
- 2 Place the probe shaft and move it about in hot water. Then blow out with air or clean with a round brush (e.g. brass).
 - ▶ Probe shafts with preliminary filter: blow compressed air through the preliminary filter. For thorough cleaning, use an ultrasonic bath or a cleaner for dentures. Screw the preliminary filter back on to the probe shaft after cleaning.
- 3 Attach the probe shaft back on the probe handle and secure by turning the threaded ring clockwise.

H.5 Replacing probe preliminary filter

- ▶ Unscrew the preliminary filter from the probe shaft and screw on a new filter.

H.6 Replacing thermocouple



! Remove the thermocouple only if defective.

- 1 Pull the bend protection spring of the rearmost tube outlet from the guide by turning it anticlockwise.
- 2 Pull the tube with thermocouple line from the guide.
- 3 Extract the thermocouple by pulling the line out of the probe handle and to the rear.
- 4 Pull the bend protection spring over the thermocouple and remove it.
- 5 Extract the line of the thermocouple from the slit tube.
- 6 Insert the line of the new thermocouple into the slit tube.
- 7 Push the bend protection spring over the thermocouple and the slit tube.

- 8 Carefully push the thermocouple through the probe handle and into the probe shaft, making sure that the thermocouple does not kink!
- 9 Push the slit tube into the guide.
- 10 Push the bend protection spring over the guide by pressing and simultaneously turning it clockwise.

H.7 Changing the printer paper

See *Setting up printer*, p. 32.

H.8 Changing batteries/rechargeable batteries

See *Changing batteries*, p. 19.

H.9 Changing the condensate pump

The condensate pump is only available in instruments with the gas preparation (**GP**) option.



- 1 Empty the condensation trap.
- 2 Place the flue gas analyzer on its front, undo both screws of the pump compartment cover and remove the cover.
- 3 Unlock the two lateral clip locks of the condensate pump and withdraw the pump.
- 4 Pull the inlet and outlet tube from the connecting nipples of the flue gas analyzer.
- 5 Remove the bend protection spring from the inlet tube and push it onto the inlet tube of the new pump.
- 6 Attach the inlet and outlet tube to the connecting nipples of the flue gas analyzer.
- 7 Push onto the motor shaft until the clip locks engage. Make sure that the tubes are not pinched or constrained.
- 8 Attach the cover.

I. Questions and answers

This chapter gives answers to frequently asked questions.

| Question | Possible causes | Remedy |
|---|--|---|
| Rech. battery low | - | ▶ Switch to mains operation. |
| Measuring instrument keeps switching itself off or measuring system will not switch on | Batteries/rech. batteries empty. | ▶ Charge rechargeable battery or switch to mains operation (see <i>Operation</i> , p. 19). |
| NO value drifts | Aux. voltage for NO measuring cell was interrupted, e.g. by change of cell | ▶ Wait until cell is regenerated. Stable NO measuring not possible until approx. 2 h after. |
| Double module | One measuring cell of the same type is already inserted. | - |
| Dilution | Gas flow rate in dilution path too high / too low. | ▶ Please contact your dealer or Testo customer service. |
| O2 cell used up | - | ▶ Replace O2 measuring cell. |
| ... signal too high | Signal of indicated measuring cell is too high. | ▶ Wait until regenerated (additional zeroing starts automatically). |
| ... Signal not stable | Signal of indicated measuring cell drifts too much (faulty). | ▶ Replacing measuring cell. |
| ... Switch-off | Reading of indicated measuring cell is above the set switch-off threshold | - |
| Instrument temperature | Instrument temperature is outside the operating temperature range | - |
| Pump volumetric flow rate | Gas flow rate too low (filter clogged) or gas flow rate too high (positive pressure). | ▶ Check gas path/filter. |
| Gas cooling system | Gas cooler not working (faulty). | ▶ Please contact your dealer or Testo customer service. |
| Cell temperature too high | O2 cell temperature outside the specifications | - |

If we could not answer your question, please contact your dealer or Testo Customer Service. Contact details can be found on the guarantee card or on the Internet under www.testo.com.

J. Technical data

J.1 Tests and accreditations

- This product fulfils the guidelines in compliance with 2004/108/EG according to the conformity certificate
- This product is TÜV tested, test mark: TÜV By RgG 211
- Option Bluetooth® Type: Ezurio BISM 2 TRBLU23-00200-03



Product notice Bluetooth®: QPN47077B
Identification Bluetooth®: B02456
Company Bluetooth®: 10274

Certification:

EU countries

Belgium (BE), Bulgaria (BG), Denmark (DK), Germany (DE), Estonia (EE), Finland (FI), France (FR), Greece (GR), Ireland (IE), Italy (IT), Latvia (LV), Lithuania (LT), Luxembourg (LU), Malta (MT), Netherlands (NL), Austria (AT), Poland (PL), Portugal (PT), Romania (RO), Sweden (SE), Slovakia (SK), Slovenia (SI), Spain (ES), Czech Republic (CZ), Hungary (HU), United Kingdom (GB) and Republic of Cyprus (CY).

Other EFTA Countries

Iceland, Liechtenstein, Norway and Switzerland

Non-European countries

Japan, Canada, USA

Information of the FCC (Federal Communications Commission)

Contains FCC ID: PI403B

- Paragraph 15.19 Labeling requirements
- This instrument fulfills Part 15 of the FCC guidelines
- Commissioning of this instrument is subject to the two conditions:
 1. This instrument may not cause any dangerous interference
 2. This device must accept any interference received, including interference that may cause undesired operation.

Changes

The FCC requires that the user is informed of the fact that all changes and modifications to the instrument which are not expressly authorized by Testo AG can invalidate the user's right to use the instrument.

EC conformity declaration



EG-Konformitätserklärung

EC declaration of conformity

Für die nachfolgend bezeichneten Produkte:

We confirm that the following products:

Meßsystem Testo 350S

measuring system testo 350S

| | |
|--------------|----------------------------------|
| Control unit | Best. Nr. / Order No.: 0563 0389 |
| Control unit | Best. Nr. / Order No.: 0563 0360 |
| Analysis box | Best. Nr. / Order No.: 0563 0368 |

wird bestätigt, daß sie den wesentlichen Schutzanforderungen entsprechen, die in der Richtlinie des Rates zur Angleichung der Rechtsvorschriften der Mitgliedstaaten über die **elektromagnetische Verträglichkeit** (89/336/EWG), und bei bestimmungsmäßiger Verwendung den grundlegenden Anforderungen gemäß Artikel 3 der R&TTE-Richtlinie 1999/5/EG, sowie der Niederspannungs Richtlinie (72/23/EWG) entspricht.
Diese Erklärung gilt für alle Geräte der oben genannten Serie.
Zur Beurteilung der Ergebnisse hinsichtlich elektromagnetischer Verträglichkeit wurden folgende Normen herangezogen:

corresponds with the main protection requirements which are fixed in the EEC "Council Directive 89/336 EEC on the approximation of the laws of the member states relating to electromagnetic compatibility" and comply with the essential requirements of Article 3 of the R&TTE 1999/5/EC Directive and the Low voltage directive (72/23/EWG).
The declaration applies to all samples of the above mentioned product.

For assessment of the product following standards have been called upon:

| | |
|--|--------------------------------|
| Störausendung / Perturbating radiation: | DIN EN 61000-6-4 : 2002-08 |
| Störfestigkeit / Perturbating resistance: | DIN EN 50270 : 2000-01 Typ 2 |
| Niederspannungs Richtlinie / Low voltage directive: | DIN EN 61010-1:2001 |
| R&TTE Richtlinie: | EN 300 328 V1.6.1 (2004-11) |
| | EN 301 489-1 V1.4.1 (2002-08) |
| | EN 301 489-17 V1.2.1 (2002-08) |
| | EN 60950-1:2001 |

Sicherheits-Richtlinie:

Diese Erklärung wird für:

This declaration is given in responsibility for:

Testo AG
Postfach / P.O. Box 1140
79849 Lenzkirch / Germany
www.testo.com

abgegeben durch / by:

Herr Walliser Mr. Walliser
(Name) (name)

Vorstand Managing Director
(Position in the company of the manufacturer) (Position in the company of the manufacturer)

Lenzkirch/24.06.2008
(Ort, Datum / Place, date)

(Rechtsgültige Unterschrift / Legally valid signature)



Our manufacturer complies with certified quality assurance system
Qualitätswertungssystem nach DIN ISO 9001
The manufacturer operates a certified quality assurance system according to DIN ISO 9001

J.2 Measuring ranges and accuracies

Testo 350-S flue gas analyzer

| Parameter | Measuring range | Accuracy | Resolution | Response time ¹⁾ |
|---|-----------------|--|---|--|
| O ₂ | 0...25 vol. % | ±0.2 vol. % | 0.01 vol. % | 20 s (t ₉₅) |
| CO, H ₂ -comp. | 0...10000 ppm | ±10 ppm ±5 % of reading ±10 % of reading | (0...99 ppm) (100...2,000 ppm) (2,001...10,000 ppm) | 1 ppm 40 s (t ₉₀) |
| CO _{low} , H ₂ -comp. | 0...500 ppm | ±2 ppm ±5 % of reading | (0.0...39.9 ppm) (40.0...500.0 ppm) | 0.1 ppm 40 s (t ₉₀) |
| CO ₂ (IR) | 0...50 vol. % | ±0.3 vol. % + 1 % of reading ±0.5 vol. % + 1.5 % of reading | (0.00...25.00 vol. %) (25.1...50.0 vol. %) | 0.01 vol. % 0.1 vol. % 10 s (t ₉₀) |
| N ₂ | 0...500 ppm | ±5 ppm ±5 % of reading | (0.0...99.0 ppm) (100.0...500.0 ppm) | 0.1 ppm 40 s (t ₉₀) |
| SO ₂ | 0...5000 ppm | ±5 ppm ±5 % of reading ±10 % of reading | (0...99 ppm) (100...2,000 ppm) (2,001...5,000 ppm) | 1 ppm 30 s (t ₉₀) |
| NO _{low} | 0...300 ppm | ±2 ppm ±5 % of reading | (0.0...39.9 ppm) (40.0...300.0 ppm) | 0.1 ppm 30 s (t ₉₀) |
| NO | 0...3000 ppm | ±5 ppm ±5 % of reading ±10 % of reading | (0...99 ppm) (100...1,999 ppm) (2,000...3,000 ppm) | 1 ppm 30 s (t ₉₀) |
| H ₂ S | 0...300 ppm | ±2 ppm ±5 % of reading | (0...39.9 ppm) (40.0...300 ppm) | 0.1 ppm 35 s (t ₉₀) |

¹⁾ Recommended minimum duration of measurement to guarantee correct readings: 3 min.

| Parameter | Measuring range | Accuracy | | Resolution | Response time ¹⁾ |
|------------------|--|--------------------------------|---------------------------------------|------------|-----------------------------|
| HC ²⁾ | 100...40,000 ppm (methane) 100...21,000 ppm (propane) 100...18,000 ppm (butane) | ±400 ppm ±10 % of reading | (100...40,000 ppm) (rest of range) | 10 ppm | 40 s (t90) |
| Draught | -40...40 hPa | ±0.03 hPa ±1.5 % of reading | (-2.99...2.99 hPa) (rest of range) | 0.01 hPa | - |
| dP | -200...200 hPa | ±0.5 hPa ±1,5 % of reading | (-49.9...49.9 hPa) (rest of range) | 0.1 hPa | - |
| Temperature | -40...1,200°C | ±0.5 °C ±0.5 % of reading | (-40.0...99.9 °C) (rest of range) | 0.1 °C | depending on the probe |
| Efficiency | 0...120 % | - | | 0.1 % | - |
| Flue gas loss | -20.0...99.9 % | - | | 0.1 % | - |

1) Recommended minimum duration of measurement to guarantee correct readings: 3 min

2) Min. O₂ requirement in flue gas: 2 % + 2x reading (methane), 2 % + 5x reading (propane), 2 % + 6.5x reading (butane); calibrated in factory to methane, response factor: 1.5 (propane), 2 (butane)

Testo 350-S flue gas analyzer, CO dilution (CO measuring range extension option)

| Parameter | Measuring range | Accuracy |
|------------------------------|------------------------------|----------------------------------|
| CO, H ₂ -comp. | 0...400,000 ppm (maximum) | +2 % of reading additional error |
| COlow, H ₂ -comp. | 0...20,000 ppm (maximum) | +2 % of reading additional error |

Testo 350-S flue gas analyzer, dilution overall (fresh air valve option)

| Parameter | Measuring range | Accuracy | dP ¹⁾ |
|------------------------------|-----------------|----------------------------------|------------------|
| CO, H ₂ -comp. | 2500...50000ppm | ±5 % of reading additional error | -150...0 hPa |
| COlow, H ₂ -comp. | 2500...50000ppm | ±5 % of reading additional error | -100...0 hPa |
| NO ₂ | 2500...50000ppm | ±5 % of reading additional error | -50...0 hPa |
| SO ₂ | 500...25000ppm | ±5 % of reading additional error | -100...0 hPa |
| NOlow | 300...1500ppm | ±5 % of reading additional error | -150...0 hPa |
| NO | 1500...15000ppm | ±5 % of reading additional error | -100...0 hPa |
| H ₂ S | 200...1500ppm | ±5 % of reading additional error | -100...0 hPa |

1) Accuracies only valid in the range of the given pressure difference
(pressure at the probe tip)



J.3 Other instrument data

| Characteristic | Values |
|--|---|
| Measuring system | |
| Operating temperature | -5...45 °C |
| Storage/transport temperature | -20...50 °C |
| Housing | ABS |
| Guarantee (according to Testo guarantee terms) | Measuring instrument: 24 months (excluding printing mechanism) Measuring cells: 12 months, O ₂ measuring cell: 18 months, CO ₂ (IR) measuring cell: 24 months Flue gas probe: 24 months, thermocouple: 12 months Rechargeable battery: 12 months |
| testo 350-S control unit | |
| Power supply | 4x mignon AA 1.5V |
| Battery service life | approx. 2 years |
| Dimensions (L x W x H) | 252 x 115 x 58 mm |
| Weight | approx. 850 g |
| Testo 350-S flue gas analyzer | |
| Power supply | Rechargeable battery pack (8.4 V/4.5 Ah) Integrated mains unit (90-260 V, 47-63 Hz, 0.3 A/230 VAC, 0.5 A/110 VAC) |
| Rech. battery charge time | approx. 4-5 h |
| Dimensions (L x W x H) | 395 x 275 x 95 mm |
| Weight | approx. 3,200 g |
| Memory | 250,000 readings |
| Max. flue gas positive pressure | 50 hPa |
| Max. vacuum | 200 hPa |
| Pump volumetric flow rate | 0.8 m/s, monitored |
| Diluting gas | Fresh air or nitrogen |
| Max. flue gas dust load | 20 g/m ³ |
| Max. humidity load | 70 °Ctd at measuring inlet |
| Trigger input (optional) | Voltage: 5...12 V (falling or rising flank) Pulse width: >1 s Load: 5 V/max. 5 mA, 12 V/max.40 mA |
| Option Bluetooth® | Range < 100m |

J.4 Principles of calculation

J.4.1 Fuel parameters

| Fuel | A2 1) | B 1) | f 1) | CO ₂ max 2) | O ₂ reference 2) | F _{Br} 3) |
|-----------------------|-------|-------|------|------------------------|-----------------------------|--------------------|
| Light fuel oil | 0.68 | 0.007 | - | 15.4 vol.% | 3 vol.% | 0.2464 |
| Natural gas | 0.66 | 0.009 | - | 11.9 vol.% | 3 vol.% | 0.2411 |
| LPG | 0.63 | 0.008 | - | 13.7 vol.% | 3 vol.% | 0.2763 |
| Anthracite | - | - | 0.74 | 20.5 vol.% | 8 vol.% | 0.2633 |
| Anthracite briquettes | - | - | 0.75 | 18.9 vol.% | 8 vol.% | 0.3175 |
| Wood fuels, coke | - | - | 0.74 | 20.3 vol.% | 8 vol.% | 0.2532 |
| Brown coal, peat | - | - | 0.90 | 19.8 vol.% | 8 vol.% | 0.2617 |
| Coke oven gas | 0.60 | 0.011 | - | 10.3 vol.% | 3 vol.% | 0.2220 |
| Heavy fuel oil | - | - | 0.61 | 15.9 vol.% | 3 vol.% | 0.2458 |
| Fuel 1 2) | 0.68 | 0.007 | - | 15.4 Vol.% | 3 Vol.% | 0.2462 |
| Fuel 2 2) | 0.66 | 0.009 | - | 11.9 Vol.% | 3 Vol.% | 0.2411 |

1) Fuel-specific parameter

2) Default setting, values can be customised

3) Conversion factor mg/m³ to ing/GJ

J.4.2 Calculation formulae

| | | |
|-----------------|---|---|
| Carbon dioxide: | $CO_2 = \frac{CO_{2max} \times (O_{2ref} - O_2)}{O_{2ref}}$ | <p>CO₂max: Fuel-specific carbon dioxide value</p> <p>O₂ref: O₂ reference value</p> <p>O₂: Measured oxygen content as %</p> |
| Flue gas loss: | $qA = \left((FT - AmbT) \times \left(\frac{A2}{O_{2ref} - O_2} + B \right) \right) - C_c$ | <p>FT: Flue gas temperature</p> <p>AmbT: Combustion air temperature</p> <p>A2/B: Fuel-specific parameters</p> <p>O₂ref: O₂ reference value</p> <p>O₂: Measured oxygen content as %</p> <p>C_c: Calculated value taking into account the recovered condensation heat when the dew point is undershot (for condensing furnaces).</p> |

If the fuel-specific parameters A2 and B are zero, qA is calculated using the Siegert formula:

$$qA = f \times \frac{(FT - AmbT)}{CO_2}$$

FT: Flue gas temperature
AmbT: Combustion air temperature
f: Fuel-specific parameter
CO₂: Calculated carbon dioxide value

Efficiency:

$$\eta = 100 - qA$$

qA: Calculated flue gas loss

Air ratio:

$$\lambda = \frac{CO_{2max}}{CO_2}$$

CO_{2max}: Fuel-specific carbon dioxide value
CO₂: Calculated carbon dioxide value

Nitrogen oxides:

no NO₂ measuring cell inserted:
NO_x = NO + (NO_{2add} x NO)
NO₂-measuring cell inserted:
NO_x = NO + NO₂

NO: Measured nitrogen monoxide value
NO_{2add}: Nitrogen addition factor

Carbon monoxide undiluted:

$$uCO = CO \times \lambda$$

CO: Measured carbon monoxide value
λ: Calculated air ratio

Flue gas dew point:

$$td = \frac{\ln \left(\frac{F_{H2O} \times P_{Abs}}{610,78} \right) \times 234,175}{\ln \left(\frac{F_{H2O} \times P_{Abs}}{610,78} \right) - 17,08085}$$

F_{H2O}: Flue gas-specific water vapour content as vol. %
P_{Abs}: Absolute pressure in mbar/hPa

Flow speed:

$$v = \sqrt{\frac{575 \times \Delta P \times (AT + 273,15)}{P_{abs}}} \times \alpha$$

P_{abs}: Absolute pressure
ΔP: Differential pressure
AT: Flue gas temperature
α: Pitot tube factor

Volume flow

$$V = v \times a$$

v: Flow speed
a: Cross-sectional area

Mass flow:

Mass flow CO: $M_{CO} = CO \text{ [kg/h] [ppm]} \times F_{Gas} \times 1.25 \text{ [kg/m}^3\text{]} \times Z$

Mass flow NO_x: $M_{NO_x} = NO_x \text{ [kg/h] [ppm]} \times F_{Gas} \times 2.05 \text{ [kg/m}^3\text{]} \times Z$

Mass flow SO₂: $M_{SO_2} = SO_2 \text{ [kg/h] [ppm]} \times F_{Gas} \times 2.86 \text{ [kg/m}^3\text{]} \times Z$

F_{gas}: Fuel-specific humidity value
T: Dew point
Z: Calculation term (see below)

Calculation term Z: $Z = \frac{273.15 \times P_{abs} \text{ [mbar]}}{273.15 + T \text{ [}^\circ\text{C]} \times 1013} \times V \text{ [m}^3\text{/s]} \times 10^{-6} \text{ [1/ppm]} \times 3600$

Conversion from ppm to mg/m³:

Carbon monoxide $CO \text{ [mg/m}^3\text{]} = \frac{O_{2ref} - O_{2Bez}}{O_{2ref} - O_2} \times CO \text{ [ppm]} \times 1.25$

Nitrogen oxides: $NO_x \text{ [mg/m}^3\text{]} = \frac{O_{2ref} - O_{2Bez}}{O_{2ref} - O_2} \times NO_x \text{ [ppm]} \times 2.05$

Sulphur dioxide: $SO_2 \text{ [mg/m}^3\text{]} = \frac{O_{2ref} - O_{2Bez}}{O_{2ref} - O_2} \times SO_2 \text{ [ppm]} \times 2.86$

O_{2ref}: O₂ reference value
O₂: Measured oxygen content as %
O_{2Bez}: Fuel-specific oxygen reference number as %

J.5 Recommended rinsing times

Recommended rinsing times for measurements involving high concentrations and lengthy measurements:

- Rinsing the instrument: Expose the probe to fresh air and start flue gas measurement.

| Parameter | Concentration [ppm] | Meas. period [min] | Recommended rinsing time [min] |
|-------------------|---------------------|--------------------|--------------------------------|
| CO | 50 | 60 | 5 |
| | 100 | 30 | 5 |
| | 200 | 20 | 10 |
| | 500 | 10 | 10 |
| | 1,000 | 10 | 15 |
| | 2,000 | 10 | 20 |
| | 4,000 | 5 | 30 |
| | 8,000 | 5 | 60 |
| CO _{low} | 10 | 60 | 5 |
| | 20 | 30 | 5 |
| | 50 | 20 | 10 |
| | 100 | 10 | 10 |
| | 200 | 10 | 15 |
| NO | 50 | 60 | 5 |
| | 100 | 45 | 5 |
| | 200 | 30 | 5 |
| | 500 | 20 | 10 |
| | 1,000 | 10 | 10 |
| | 2,000 | 10 | 20 |
| | 3,000 | 5 | 30 |
| NO _{low} | 10 | 60 | 5 |
| | 20 | 45 | 5 |
| | 50 | 30 | 5 |
| | 100 | 20 | 10 |
| | 200 | 10 | 10 |
| NO ₂ | 10 | 60 | 5 |
| | 20 | 45 | 5 |
| | 50 | 30 | 5 |
| | 100 | 20 | 10 |
| | 200 | 10 | 10 |
| | 500 | 10 | 20 |
| SO ₂ | 50 | 60 | 5 |
| | 100 | 30 | 5 |
| | 200 | 20 | 10 |
| | 500 | 15 | 10 |
| | 1,000 | 10 | 10 |
| | 2,000 | 10 | 20 |
| | 5,000 | 5 | 40 |
| H ₂ S | 10 | 40 | 5 |
| | 20 | 30 | 5 |
| | 50 | 20 | 10 |
| | 100 | 10 | 10 |
| | 200 | 5 | 10 |
| | 300 | 5 | 20 |

K. Accessories/spare parts

This chapter gives important accessory and spare parts for the product.

| Designation | Article no. |
|--|-------------|
| Flue gas probes | |
| Flue gas probe, 335 mm incl. cone, thermocouple NiCr-Ni (Ti), Tmax 500 °C, 2.2 m tube | 0600 7451 |
| Flue gas probe, 700 mm incl. cone, thermocouple NiCr-Ni (Ti), Tmax 500 °C, 2.2 m tube | 0600 7452 |
| Measuring cells (for retrofitting) | |
| CO | 0554 3993 |
| COlow | 0554 3925 |
| NO | 0554 3935 |
| NOlow | 0554 3928 |
| NO2 | 0554 3926 |
| SO2 | 0554 3927 |
| CxHy | 0554 3929 |
| H2S | 0554 3930 |
| CO2(IR) | on request |
| Measuring cells (replacement) | |
| O2 | 0390 0070 |
| CO | 0390 0088 |
| COlow | 0390 0078 |
| NO | 0390 0093 |
| NOlow | 0390 0077 |
| NO2 | 0390 0075 |
| SO2 | 0390 0081 |
| CxHy | 0390 0076 |
| H2S | 0390 0079 |
| Miscellaneous | |
| Thermal paper for printer (6 rolls) | 0554 0569 |
| RS232 connecting cable for control unit/PC | 0409 0178 |
| Battery pack for flue gas analyzer | 0515 0098 |
| Battery pack for Control Unit | 0515 0097 |
| Rechargeable battery pack for flue gas analyzer | 0515 0098 |
| Cable with adapter for cigarette lighter and adapter for connection to the flue gas analyzer | 0554 1336 |
| Cable with battery terminals and adapter for connection to the flue gas analyzer | 0554 1337 |
| Filter for flue gas analyzer, 20 pieces, yellow | 0554 3381 |
| Transport case for flue gas analyzer, control unit, probes and accessories | 0516 0351 |

For a complete list of all accessories and spare parts, please refer to the product catalogues and brochures or look up our website www.testo.com

testo AG

Postfach 11 40, 79849 Lenzkirch

Testo-Straße 1, 79853 Lenzkirch

Telefon: (07653) 681-0

Fax: (07653) 681-100

E-Mail: info@testo.de

Internet: <http://www.testo.com>