

5.1	Introduction	234
5.1.1	Overview	234
5.2	Reliability and Project Performance	236
5.3	Transformer Loss Evaluation	238
5.4	Power Transformers	240
5.4.1	Large Power Transformers	240
5.4.2	Medium Power Transformers	241
5.4.3	Small Power Transformers	241
5.5	Reactors	242
5.6	Special Transformers for Industrial Applications	243
5.7	Phase-Shifting Transformers	245
5.8	HVDC Transformers	246
5.9	Distribution Transformers	247
5.9.1	Liquid-immersed Distribution Transformers for European/US/Canadian Standard	247
5.9.2	Voltage Regulators	248
5.9.3	GEAFOL Cast-Resin Transformers	249
5.9.4	GEAFOL Special Transformers	254
5.10	Traction Transformers	256
5.11	Transformer Lifecycle Management	257

5 Transformers

5.1 Introduction

5.1.1 Overview

Whether in infrastructure systems, industry or households, transformers always play a key role in the reliable transmission and distribution of power. The construction, rated power, voltage level and scope of the application are all key factors that determine the transformer's design.

Siemens provides the right transformer for every need – from compact distribution transformers to large power transformers with ratings far above 1,000 MVA. The Siemens product range covers all mainstream requirements like UHV DC applications, low noise emission and environmentally friendly products with alternative insulation liquids, also embedded in a complete power system from generation via transmission to distribution networks. The long-term reliability of a transformer begins with its initial high quality. Then transformer lifecycle management measures maintain that quality throughout the transformer's entire life.

Fig. 5.1-1 and table 5.1-1 are an overview of how various transformers can be used in a network.

Global Footprint

Emerging countries are not just “extended workbenches” for producing goods. First and foremost, they are important future markets. Through its own local production and sales locations, Siemens provides service to customers in the most important global markets. The local presence of Siemens in many countries also ensures that customers have better access to Siemens services and that they benefit from an efficient and effective distribution of Siemens resources as part of a global network. As Siemens factories around the world develop and produce their products, Siemens also encourages them to share their expertise.

Siemens meets the growing global demand for transformers in a variety of ways: by further optimization of value-added steps in the worldwide network, by use of approaches such as vertical integration and by the pursuit of programs for boosting productivity.



For further information:
www.siemens.com/energy/transformers

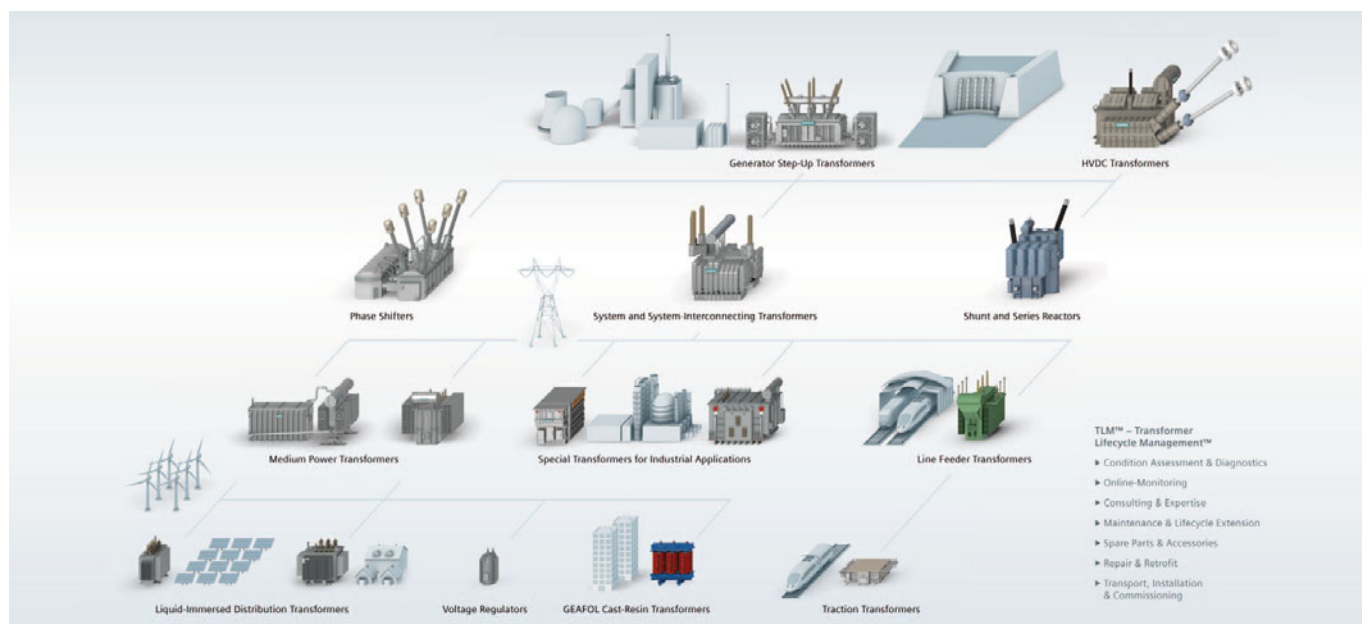

Fig. 5.1-1: Product range of Siemens transformers

	Generator and System Transformers	Above 2.5 MVA up to more than 1,000 MVA, above 30 kV up to 1,500 kV (system and system interconnecting transformers, with separate windings or auto-connected), with on-load tap changers or off-circuit tap changers, of 3-phase or 1-phase design
	Phase Shifters	To control the amount of active power by changing the effective phase displacement
	Reactors	Liquid-immersed shunt and current-limiting reactors up to the highest rated powers Reactors for HVDC transmission systems
	HVDC Transformers	Transformers and smoothing reactors for bulk power transmission systems up to 800 kV DC Transformers for DC coupling of different AC networks
	Cast-Resin Distribution and Power Transformers GEAFOLE	100 kVA to more than 40 MVA, highest voltage for equipment up to 36 kV, of 3-phase or 1-phase design, GEAFOLE-SL substations
	Liquid-immersed Distribution Transformers	50 to 2,500 kVA, highest voltage for equipment up to 36 kV, with copper or aluminum windings, hermetically sealed or with conservator of 3- or 1-phase design pole mounted transformers and distribution transformers acc. to IEC with amorphous cores
	Special Transformers for Industry	Electric arc furnace transformers Electric arc furnace series reactors DC electric arc furnace transformers Rectifier transformers Converter transformers for large drives
	Traction Transformers	Traction transformers mounted on rolling stock
	Transformer Lifecycle Management	Condition assessment & diagnostics Online monitoring Consulting & expertise Maintenance & lifecycle extension Spare parts & accessories Repair & retrofit Transport, installation & commissioning

Table 5.1-1: Product range of Siemens transformers

5.2 Reliability and Project Performance

The quality strategy in the transformer business is based on the three cornerstones of product, people and process quality (fig. 5.2-1). The objective is to achieve the greatest customer satisfaction with cost-efficient processes. This is only possible if all employees are involved in the processes have a profound understanding of the customer needs and specific requirements in the transformer business.

The strategy is implemented in the form of mandatory elements. These elements cover product and service quality, which is visible to customers; personnel quality, which is achieved by training and ongoing education; and process quality in all processes used. Business and process-specific indicators must be used to ensure that each single element is measurable and transparent.

Nine mandatory elements are defined:

- Customer integration
- Embedded quality in processes and projects
- Consequent supplier management
- Business-driven quality planning
- Focused quality reporting
- Qualification of employees on quality issues
- Continuous improvement
- Management commitment
- Control and support role of quality manager

Elements of quality (mandatory elements)

Customer integration

Customer integration depends on the consistent use of:

- Analysis tools for customer requirements and market studies
- Analysis of customer satisfaction
- Professional management of feedback from and to the customer
- Complaint management

Customer requirements need to be precisely defined in a specification. And the specification must be continuously updated throughout the definition phase of a transformer project. The actual requirements must also be available to all responsible employees.

Rapid feedback loops – in both directions – are essential in order to increase customer trust and satisfaction.

Siemens resolves customer complaints to the customer's satisfaction in a timely manner through its complaint management system.

Embedded quality in processes and projects

The quality of the processes used to produce a product has a significant impact on the quality of the product that is actually produced. Process discipline and process stability can be

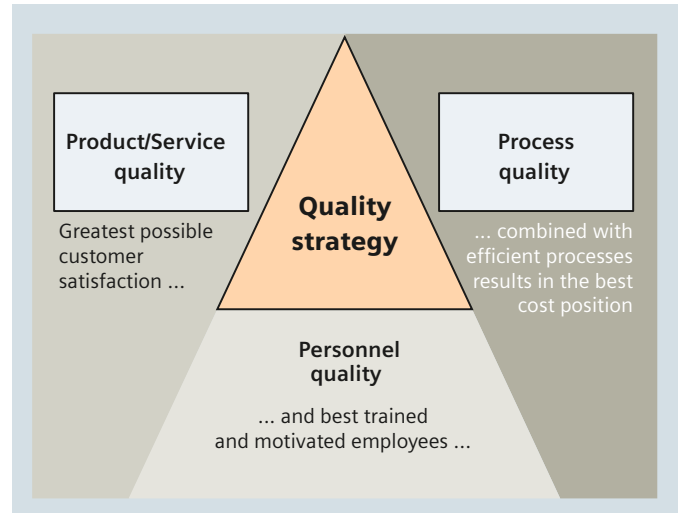

Fig. 5.2-1: Cornerstones of quality strategy

achieved by a high degree of process standardization. All processes should be standardized for all employees based on simple procedures. If this condition is met, it is possible to implement clearly defined work instructions (fig. 5.2-2).

Quality gates are placed at points in the process at which quality-relevant decisions are necessary. The following quality gates are mandatory for the power transformer business.

- Bid approval
- Entry order clarified
- Release of design
- Release of fully assembled transformer
- Evaluation of project

For each quality gate, there is a clear definition of participants, preconditions, results (traffic light) and the escalation process, if necessary. If the result is not acceptable, the process must be stopped until all requirements are fulfilled.

Supplier management

The quality of the product depends not only on the quality of the own processes but also on that of the suppliers. Problems and costs caused by inadequate supplier quality can only be reduced by a systematic supplier management process that includes:

- Selection
- Assessment
- Classification
- Development
- Phasing out of suppliers as well as the support process Supplier Qualification

A further condition for a high level of supplier quality is close cooperation with the suppliers. Joint development of requirements for suppliers and processes leads to continuous improvements in quality. In this context, supplier know-how can also be used to create innovations. This aspect of the relationship with suppliers is becoming more and more important, especially in the transformer business.

Business-driven quality planning

Planning quality means analyzing possible future scenarios and anticipated problems and taking preventive steps to solve those problems. It is crucial that both current and future critical business factors are considered in planning. That means that quality is based on business-driven planning and specific objectives, activities and quantitative indicators.

Focused quality reporting

Reporting is based on:

- Focused key performance indicators such as non-conformance costs, external failure rate, internal failure rate and on-time delivery
- Concrete quality incidents
- Root cause analysis of quality problems including definition of corrective and preventive measures

For customers, the reliability of transformers is of special importance. ANSI C57.117 has made an attempt to define failures. Based on this definition, statistics on in-service failures and reliability values can be derived. An example for power transformers appears in table 5.2-1.

Qualification of employees on quality issues

People are the decisive factor influencing quality. Therefore, all employees involved in the processes must have the skills and abilities appropriate to the quality aspects of the process steps they perform. Any qualification measures that may be necessary must be determined on the basis of a careful analysis of existing deficits.

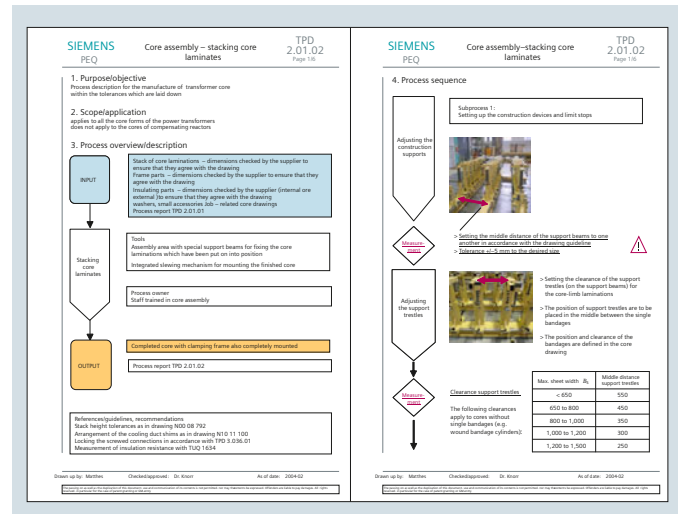

Fig. 5.2-2: Example of standardized working instruction

Continuous improvement

Because “there is nothing that cannot be improved”, continuous improvement must be an integral part in all processes.

The objective is to continue optimizing each process step. This is also the purpose of improvement teams. Appropriate coaching of these teams should make it possible to reach almost all employees.

E T TR In-Service Failure Statistic 2000 – 2009 for Power Transformers

based on ANSI C 57.117

	E T TR	Plant 1	Plant 2	Plant 3	Plant 4	Plant 5	Plant 6	Plant 7*	Plant 8	Plant 9	Plant 10	Plant 11	Plant 12	Plant 13*	Plant 14**	Plant 15
N	11,278	572	1,704	755	793	774	534	–	735	1,076	705	649	994	–	1007	980
SY	51,429	2,358	7,479	3,858	3	4,326	1,996	–	3,341	4,561	4,17	2,889	4,899	–	3,781	4,771
n _F	91	9	7	10	11	1	11	–	3	6	2	7	8	–	3	13
FR _e (%)	0.18	0.38	0.09	0.26	0.37	0.02	0.55	–	0.09	0.13	0.05	0.24	0.16	–	0.08	0.27
MTBF (yrs)	565	262	1068	386	273	4,326	181	–	1,114	760	2,085	413	612	–	1,26	367

* Plant 7 & 13: new plants; ** Plant 14: 9 years 2001 – 2009

N = No. of units in service

SY = No. of service years

n_F = No. of units failed

FR_e (%) = Failure rate = n_F × 100/SY

MTBF (yrs) = Mean time between failures = 100/FR_e

FR_e ≤ 0.5 % excellent

0.5 % < FR_e ≤ 1.0 % good

1.0 % < FR_e ≤ 1.5 % satisfactory

1.5 % < FR_e ≤ 2.0 % acceptable

FR_e > 2.0 % not acceptable

Table 5.2-1: In-service failure statistic

Methods like, Kaizen, 5S and methods and tools from Six Sigma e.g. DMAIC circle, FMEA, IPO are helpful in supporting this continuous improvement process (fig. 5.2-3).

Management commitment

Every manager in a company also bears responsibility for quality. Thus, each manager's actions must be characterized by a high level of quality awareness.

The level of commitment shown by all levels of management in the event of quality problems, the establishment of quality demands and the creation of targeted quality controls in day-to-day work together produce a culture in which there is a high level of quality.

Control and support role of the quality manager

The role of the quality manager is of fundamental importance for well-running processes. The quality manager combines a supporting role with that of a neutral controller. Quality management must be directly involved in processes and projects. The independence of the quality department and individual quality managers in the processes and projects must be guaranteed and agreed by top management.

Conclusion

The quality of a transformer is based on the quality of all processes that are necessary – from project acquisition to project closing. The quality of the processes depends essentially on people. Only well-trained and motivated employees are able to guarantee that a process will be performed with a high degree of quality.

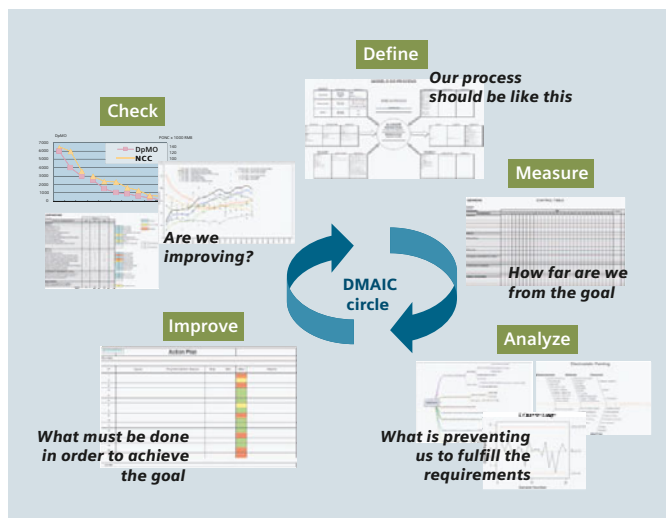

Fig. 5.2-3: DMAIC circle

ANSI Standard C57.117, 1986,
Guide for Reporting Failure Data for Power Transformers
and Shunt Reactors on Electric Utility Power Systems.

5.3 Transformer Loss Evaluation

The sharply increased cost of electrical energy has made it almost mandatory for buyers of electrical machinery to carefully evaluate the inherent losses of these items. For distribution and power transformers, which operate continuously and most frequently in loaded condition, this consideration is especially important. As an example, the added cost of loss-optimized transformers can in most cases be recovered via savings in energy use in less than three years.

Low-loss transformers use more and better materials for their construction and are thus initially more expensive than low-cost transformers. By stipulating loss evaluation figures in the transformer inquiry, the manufacturer receives the necessary incentive to provide a loss-optimized transformer rather than the low-cost model. Detailed loss evaluation methods for transformers have been developed and are described accurately in the literature. These methods take the project-specific evaluation factors of a given customer into account.

A simplified method for a quick evaluation of different quoted transformer losses makes the following assumptions:

- The transformers are operated continuously.
- The transformers operate at partial load, but this partial load is constant.
- Additional cost and inflation factors are not considered.
- Demand charges are based on 100 % load.

The total cost of owning and operating a transformer for one year is thus defined as follows:

- Capital cost (C_C), taking into account the purchase price (C_p), the interest rate (p) and the depreciation period (n)
- Cost of no-load loss (C_{P0}) based on the no-load loss (P_0) and energy cost (C_e)
- Cost of load loss (C_{Pk}) based on the load loss (P_k), the equivalent annual load factor (a) and energy cost (C_e)
- Cost resulting from demand charges (C_d) based on the amount set by the utility and the total kW of connected load (fig. 5.3-1)

The following examples show the difference between a low-cost transformer and a loss-optimized transformer (fig. 5.3-2).

Note that the lowest purchase price is unlike the total cost of ownership.

Capital cost

taking into account the purchase price C_p , the interest rate p , and the depreciation period n

$$C_c = C_p \cdot r / 100 \quad [\text{amount/year}]$$

C_p = purchase price

$r = p \cdot q^n / (q^n - 1)$ = depreciation factor

$q = p / 100 + 1$ = interest factor

p = interest rate in % p.a

n = depreciation period in years

Cost of no-load loss

based on the no-load loss P_0 , and energy cost C_e

$$C_{P0} = C_e \cdot 8,760 \text{ h/year} \cdot P_0$$

C_e = energy charges [amount/kWh]

P_0 = no-load loss [kW]

Cost of load loss

based on the load loss P_k , the equivalent annual load factor α , and energy cost C_e

$$C_{Pk} = C_e \cdot 8,760 \text{ h/year} \cdot \alpha^2 P_k$$

α = constant operation load / rated load

P_k = copper loss [kW]

Cost resulting from demand charges

based on the no-load loss P_0 , and energy cost C_e

$$C_D = C_d (P_0 + P_k)$$

C_d = demand charges [amount/(kW · year)]

Example: Distribution transformer

Depreciation period	$n = 20$ years	} Depreciation factor $r = 13.39$
Interest rate	$p = 12$ % p.a.	
Energy charge	$C_e = 0.25$ €/kWh	
Demand charge	$C_d = 350$ €/(kW · year)	
Equivalent annual load factor	$\alpha = 0.8$	

A. Low-cost transformer

$P_0 = 19$ kW no-load loss
 $P_k = 167$ kW load loss
 $C_p = € 521,000$ purchase price

$$C_c = \frac{521,000 \cdot 13.39}{100}$$

$$= € 69,762/\text{year}$$

$$C_{P0} = 0.2 \cdot 8,760 \cdot 19$$

$$= € 33,288/\text{year}$$

$$C_{Pk} = 0.2 \cdot 8,760 \cdot 0.64 \cdot 167$$

$$= € 187,254/\text{year}$$

$$C_D = 350 \cdot (19 + 167)$$

$$= € 65,100/\text{year}$$

Total cost of owning and operating this transformer is thus:

$$€ 355,404/\text{year}$$

B. Loss-optimized transformer

$P_0 = 16$ kW no-load loss
 $P_k = 124$ kW load loss
 $C_p = € 585,000$ purchase price

$$C_c = \frac{585,000 \cdot 13.39}{100}$$

$$= € 78,332/\text{year}$$

$$C_{P0} = 0.2 \cdot 8,760 \cdot 16$$

$$= € 28,032/\text{year}$$

$$C_{Pk} = 0.2 \cdot 8,760 \cdot 0.64 \cdot 124$$

$$= € 139,039/\text{year}$$

$$C_D = 350 \cdot (16 + 124)$$

$$= € 49,000/\text{year}$$

Total cost of owning and operating this transformer is thus:

$$€ 294,403/\text{year}$$

The energy saving of the optimized distribution transformer of **€ 61,001 per year** pays for the increased purchase price in less than one year.

Fig. 5.3-1: Calculation of the individual operation cost of a transformer in one year

Fig. 5.3-2: Example for cost saving with optimized distribution transformer

5.4 Power Transformers

5.4.1 Large Power Transformers

In the power range above 250 MVA, generator and network intertie transformers with off-load or on-load tap changers, or a combination of both, are recommended. Depending on the on-site requirements, they can be designed as multiwinding transformers or autotransformers, in 3-phase or 1-phase versions. Even with ratings of more than 1,000 MVA and voltages up to 1,200 kV (800 kV), the feasibility limits have not yet been reached. We manufacture these units according to IEC 60076 as well as other international and national standards (e.g., ANSI/IEEE), (fig. 5.4-1).

Generator step-up (GSU) transformers

GSU units transform the voltage up from the generator voltage level to the transmission voltage level, which may be as high as 1,200 kV system voltage. Such transformers are usually YNd-connected.

In order to make an inquiry regarding a GSU power transformer, the technical data for the items in this section are required.

Step-down transformers

Step-down transformers transform the voltage down from the transmission voltage level to an appropriate distribution voltage level. The power rating of step-down transformers may range up to the power rating of the transmission line.

System interconnecting transformers

System interconnecting transformers connect transmission systems with different voltages together so that active as well as reactive power can be exchanged between the systems.

Main specification data

- Standard
- Installation – indoor/outdoor
- Max. ambient air temperature
- Rated frequency f
- Vector group
- Rated power S
- Primary rated voltage U_{rHV}
- Tapping range/taps
- Voltage regulation
- Secondary rated voltage U_{rLV}
- Impedance u_k at S_r and U_r
- Max. sound power level L_{WA}
- Insulation level HV-Ph – $U_m/AC/LI$
- Insulation level HV-N – $U_m/AC/LI$
- Insulation level LV-Ph – $U_m/AC/LI$
- Type of cooling
- HV connection technique
- LV connection technique
- Transportation medium
- Losses



Fig. 5.4-1: Large power transformer

5.4.2 Medium Power Transformers

Medium power transformers with a power range from 30 to 250 MVA and a voltage of over 72.5 kV are used as network and generator step-up transformers (fig. 5.4-2).

Specific items

- Transformer design according to national and international standards (IEC/ANSI) with or without voltage regulation
- 3-phase or 1-phase
- Tank-attached radiators or separate radiator banks

Main specification data

- Number of systems (HV, LV, TV)
- Voltage and MVA rating
- Regulation range and type
- Vector group
- Frequency
- Losses or capitalization
- Impedances
- Type of cooling
- Connection systems (bushing, cable)
- Noise requirements (no-load, load and/or total noise)
- Special insulation fluid
- Application of high temperature/extra small size operation



Fig. 5.4-2: Medium power transformer with natural oil based insulation fluid

5.4.3 Small Power Transformers

Small power transformers are distribution transformers from 5 to 30 MVA with a maximum service voltage of 145 kV. They are used as network transformers in distribution networks (fig. 5.4-3).

This type of transformer is normally a 3-phase application and designed according to national and international standards. The low-voltage windings should be designed as foil or layer windings. The high-voltage windings should use layer or disc execution, including transposed conductors. Normally, the cooling type is ONAN (oil-natural, air-natural) or ONAF (oil-natural, air-forced). The tapping can be designed with off-circuit or on-load tap changers (OCTC or OLTC).

Main specification data

- Voltage and MVA rating
- Frequency
- Regulation range and type
- Vector group
- Losses or capitalization
- Impedances
- Noise requirements
- Connection systems (bushing, cable)
- Weight limits
- Dimensions
- Information about the place of installation
- Special insulation fluid
- Application of high temperature/extra small size operation
- Type of cooling



Fig. 5.4-3: Small power transformer

5.5 Reactors

In AC networks, shunt reactors and series reactors are widely used in the system to limit the overvoltage or to limit the short-circuit current. With more high-voltage overhead lines with long transmission distance and increasing network capacity, both types of reactors play an important role in the modern network system.

Made for every requirements

Oil filled reactors are manufactured in two versions:

- With an iron core divided by air gaps
- Without an iron core, with a magnetic return circuit

Oil filled reactors offer individual solutions: They satisfy all the specified requirements regarding voltage, rating, type of operation, low-noise and low loss and type of cooling, as well as transportation and installation.

The windings, insulation tank monitoring devices and connection method are practically the same as those found in the construction of transformers.

Shunt reactors

For extra-high-voltage (EHV) transmission lines, due to the long distance, the space between the overhead line and the ground naturally forms a capacitor parallel to the transmission line, which causes an increase of voltage along the distance. Depending on the distance, the profile of the line and the power being transmitted, a shunt reactor is necessary either at the line terminals or in the middle. An liquid-immersed shunt reactor is a solution. The advanced design and production technology will ensure the product has low loss and low noise level.

Shunt reactors also can be built as adjustable shunt reactors. This offers the possibility in fine tuning the system voltage and also the reduction of high voltage equipment by substitution of several unregulated reactors by a regulated one.

Series reactors

When the network becomes larger, sometimes the short-circuit current on a transmission line will exceed the short-circuit current rating of the equipment. Upgrading of system voltage, upgrading of equipment rating or employing high-impedance transformers are far more expensive than installing liquid-immersed series reactors in the line. The liquid-immersed design can also significantly save space in the substation.

Specification

Typically, 3-phase or 1-phase reactors should be considered first. Apart from the insulation level of the reactor, the vector group, overall loss level, noise level and temperature rise should be considered as main data for the shunt reactor.

Although the above data are also necessary for series reactors, the rated current, impedance and thermal/dynamic stability current should also be specified.



Fig. 5.5-1: Reactor

5.6 Special Transformers for Industrial Applications

A number of industry applications require specific industrial transformers due to the usage of power (current) as a major resource for production. Electric arc furnaces (EAF), ladle furnaces (LF) and high-current rectifiers need a specific design to supply the necessary power at a low voltage level. These transformer types, as well as transformers with direct connection to a rectifier are called special-purpose or industrial transformers, whose design is tailor-made for high-current solutions for industry applications.

Electric arc furnace transformers

EAF and LF transformers are required for many different furnace processes and applications. They are built for steel furnaces, ladle furnaces and ferroalloy furnaces, and are similar to short or submerged arc furnace transformers (fig. 5.6-1).

EAF transformers operate under very severe conditions with regard to frequent overcurrents and overvoltages generated by short-circuit in the furnace and the operation of the HV circuit-breaker. The loading is cyclic. For long-arc steel furnace operation, additional series reactance is normally required to stabilize the arc and optimize the operation of the furnace application process.

Specific items

EAF transformers are rigidly designed to withstand repeated short-circuit conditions and high thermal stress, and to be protected against operational overvoltages resulting from the arc processes. The Siemens EAF reactors are built as 3-phase type with an iron core, with or without magnetic return circuits.

Design options

- Direct or indirect regulation
- On-load or no-load tap changer (OLTC/NLTC)
- Built-in reactor for long arc stability
- Secondary bushing arrangements and designs
- Air or water-cooled
- Internal secondary phase closure (internal delta)

Main specification data

- Rated power, frequency and rated voltage
- Regulation range and maximum secondary current
- Impedance and vector group
- Type of cooling and temperature of the cooling medium
- Series reactor and regulation range and type (OLTC/NLTC)

DC electric arc furnace transformers

Direct-current electric arc furnace (DC EAF) transformers are required for many different furnace processes and applications. They are built for steel furnaces with a Thyristor rectifier. DC EAF transformers operate under very severe conditions, like rectifier transformers in general but using rectifier transformers for furnace operation. The loading is cyclic.

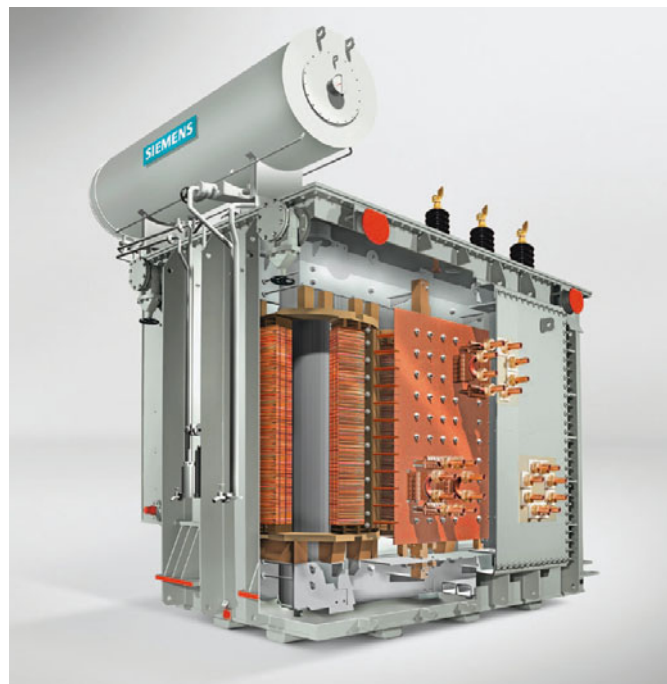

Fig. 5.6-1: Electric arc furnace transformer

Rectifier transformers

Rectifier transformers are combined with a diode or Thyristor rectifier. The applications range from very large aluminum electrolysis to various medium-size operations. The transformers may have a built-in or a separate voltage regulation unit. Due to a large variety of applications, they can have various designs up to a combination of voltage regulation, rectifier transformers in double-stack configuration, phase-shifting, interphase reactors, transductors and filter-winding (fig. 5.6-2).

Specific items

Thyristor rectifiers require voltage regulation with a no-load tap changer, if any. A diode rectifier will, in comparison, have a longer range and a higher number of small voltage steps than an on-load tap changer. Additionally, an auto-connected regulating transformer can be built in the same tank (depending on transport and site limitations).

Design options

- Thyristor or diode rectifier
- On-load or no-load tap changer (OLTC/NLTC)/filter winding
- Numerous different vector groups and phase shifts possible
- Interphase reactor, transductors
- Secondary bushing arrangements and designs
- Air or water-cooled

Main specification data

- Rated power, frequency and rated voltage
- Regulation range and number of steps
- Impedance and vector group, shift angle
- Type of cooling and temperature of the cooling medium
- Bridge or interphase connection
- Number of pulses of the transformer and system
- Harmonics spectrum or control angle of the rectifier
- Secondary bushing arrangement

Converter transformers

Converter transformers are used for large drive application, static voltage compensation (SVC) and static frequency change (SFC).

Specific items

Converter transformers are mostly built as double-tier, with two secondary windings, allowing a 12-pulse rectifier operation. Such transformers normally have an additional winding as a filter to take out harmonics. Different vector groups and phase shifts are possible.

Main specification data

- Rated power, frequency and rated voltage
- Impedance and vector group, shift angle
- Type of cooling and temperature of the cooling medium
- Number of pulses of the transformer and system
- Harmonics spectrum or control angle of the rectifier



Fig. 5.6-2: Rectifier transformer for an aluminum plant

Line Feeder

This kind of transformer realizes the connection between the power network and the power supply for the train. Transformer is operating in specific critical short circuit condition and overload condition in very high frequencies per year, higher reliability is required to secure the train running in safety.

Main specification data

- Rated power, frequency and rated voltage
- Impedance and vector group
- Overload conditions
- Type of cooling and temperature of the cooling medium
- Harmonics spectrum or control angle of the rectifier

Design options

- Direct connection between transmission network and railway overheadcontactline
- Frequency change via DC transformation (e.g. 50 Hz – 16,67 Hz)
- Thyristor or diode rectifier
- On-load or no-load tap changer (OLTC/NLTC)/filter winding
- Secondary bushing arrangements and designs
- Air or water-cooled

5.7 Phase-Shifting Transformers

A phase-shifting transformer is a device for controlling the power flow through specific lines in a complex power transmission network. The basic function of a phase-shifting transformer is to change the effective phase displacement between the input voltage and the output voltage of a transmission line, thus controlling the amount of active power that can flow in the line.

Guidance on necessary information

Beside the general information for transformers, the following specific data are of interest (fig. 5.7-1):

- **Rated MVA**
The apparent power at rated voltage for which the phase-shifting transformer is designed.
- **Rated voltage**
The phase-to-phase voltage to which operating and performance characteristics are referred to – at no-load.
- **Rated phase angle**
Phase angle achieved when the phase-shifting transformer is operated under no-load condition, or if stated at full load, at which power factor.
- **Phase shift direction**
In one or both directions. Changeover from and to under load or no-load condition.
- **Tap positions**
Minimum and/or maximum number of tap positions.
- **Impedance**
Rated impedance at rated voltage, rated MVA and zero phase shift connection as well as permissible change in impedance with voltage and phase angle regulation.
- **System short-circuit capability**
When the system short-circuit level is critical to the design of phase-shifting transformers, the maximum short-circuit fault level shall be specified.
- **BIL**
Basic impulse level (BIL) of source, load and neutral terminals.
- **Special design tests**
Besides the standard lightning impulse tests at all terminals, it has to be considered that the lightning impulse might occur simultaneously at the source and the load terminal in case of closed bypass breaker. If such a condition is likely to appear during normal operation, a BIL test with source and load terminals connected might be useful to ensure that the phase-shifting transformer can withstand the stresses of lightning strokes in this situation.
- **Special overload condition**
The required overload condition and the kind of operation (advance or retard phase angle) should be clearly stated. Especially for the retard phase angle operation, the overload requirements may greatly influence the cost of the phase-shifting transformer.



Fig. 5.7-1: Phase-shifting transformer

- **Operation of phase-shifting transformer**
Operation with other phase-shifting transformers in parallel or series.
- **Single or dual-tank design**
In most cases, a dual-core design requires a dual-tank design as well.
- **Symmetric or non-symmetric type**
Symmetric means that under a no-load condition the voltage magnitude at the load side is equal to that of the source side. For non-symmetric phase-shifting transformers, the permissible variation in percent of rated voltage at maximum phase angle must be stated.
- **Quadrature or non-quadrature type**
A quadrature-type phase-shifting transformer is a unit where the boost voltage, which creates the phase shift between source and load terminals, is perpendicular to the line voltage on one terminal.
- **Internal varistors**
It has to be clarified whether internal metal oxide varistors are allowed or not.

5.8 HVDC Transformers

HVDC transformers are key components of HVDC stations. HVDC converter and inverter stations terminate long-distance DC transmission lines or DC sea cables. This type of transformer provides the interface between AC grids and high power rectifiers and are used to control the load flow over the DC transmission lines. These actors adapt the AC grid voltage to an adequate level which is suitable for feeding the valve system of DC converter and inverter.

Design options

The design concept of HVDC transformers is mainly influenced by the rated voltage, rated power and transportation requirements like dimensions, weight and mode of transportation. Many large power HVDC converter station are located in rural areas of low infrastructure. Frequently, special geometrical profiles have to be fulfilled in order to move such transformers by railway.

Typically, HVDC transformers are single phase units containing 2 winding limbs. This concept can include either 2 parallel valve windings (two for delta or two for wye system, fig. 5.8-1) or two different valve windings (one for delta and one for wye, fig. 5.8-2). In order to reduce the total transportation height frequently the core assembly includes 2 return limbs. Due to redundancy requirements in HVDC stations 3 phase units are quite uncommon.

The valve windings are exposed to AC and DC dielectric stress and therefore a special insulation assembly is necessary. Furthermore, special lead systems connecting the turrets and windings have to be installed in order to withstand the DC voltage of rectifier. Additionally, the load current contains harmonic components of considerable energy resulting in higher losses and increased noise. Above all, special bushings are necessary for the valve side to access upper and lower winding terminals of each system from outside. Conclusively, two identical bushings are installed for star or delta system.

For approving the proper design and quality of manufacturing special applied DC and DC polarity reversal tests have to be carried out. The test bay has to be equipped with DC test apparatus accordingly and needs to provide adequate geometry to withstand the DC test voltage.

Technical items

In addition to the standard parameters of power transformers, special performance requirements have to be known for the design of HVDC transformers. These parameters are jointly defined by designers of the HVDC station and transformer design engineers in order to reach a cost-effective design for the entire equipment.

Special parameters are:

- **Test levels:** DC applied, DC polarity reversal and long-time AC defines the insulation assembly of the transformer
- **Harmonic spectrum** of the load current and phase relation

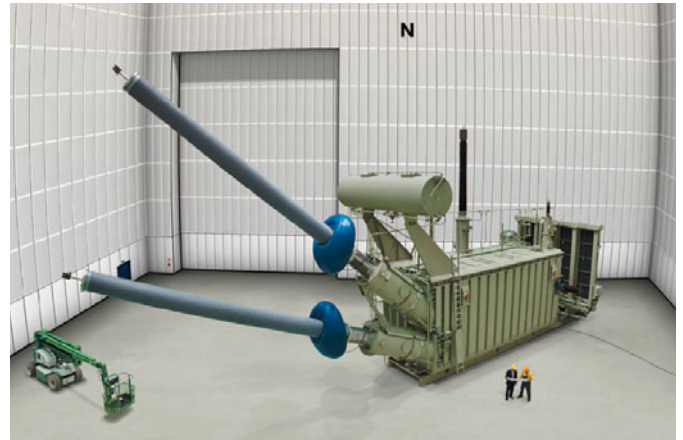

Fig. 5.8-1: Converter transformer for UHVDC bipolar transmission system ± 800 kVDC, 6,400 MW; 2,071 km: single phase; 550 kVAC, 816 kVDC; 321 MVA; high pulse wye system feeding



Fig. 5.8-2: Converter transformer for HVDC bipolar transmission system ± 500 kVDC; 2,500 MW: single phase; 420 kVAC; 515 kVDC; 397 MVA; wye system (left side of figure) and delta system (right side of figure)

generate additional losses, which have to be compensated by the cooling circuit

- **Voltage impedance** impacting the dimensions of windings and the total height of the transformer
- **DC bias** in load and current and transformer-neutral have to be considered for no-load noise and no-load losses
- **Derivative of the load current** (di/dt) is a key parameter for the on-load tap changer
- **Overload requirements** have to be considered for cooling circuit and capacity of coolers
- **Regulation range** and **number of steps** influence the voltage per turn which is a key design parameter
- **Seismic requirements** have to be considered for mechanical strength of turrets, outlets and bushings

5.9 Distribution Transformers

5.9.1 Liquid-immersed Distribution Transformers for European/US/Canadian Standard

On the last transformation step from the power station to the consumer, distribution transformers (DT) provide the necessary power for systems and buildings. Accordingly, their operation must be reliable, efficient and, at the same time, silent.

Distribution transformers are used to convert electrical energy of higher voltage, usually up to 36 kV, to a lower voltage, usually 250 up to 435 V, with an identical frequency before and after the transformation. Application of the product is mainly within suburban areas, public supply authorities and industrial customers. Distribution transformers are usually the last item in the chain of electrical energy supply to households and industrial enterprises.

Distribution transformers are fail-safe, economical and have a long life expectancy. These fluid-immersed transformers can be 1-phase or 3-phase. During operation, the windings can be exposed to high electrical stress by external overloads and high mechanical stress by short-circuits. They are made of copper or aluminum. Low-voltage windings are made of strip or flat wire, and the high-voltage windings are manufactured from round wire or flat wire.

Three product classes – standard, special and renewable – are available, as follows:

- Standard distribution transformers:
 - Pole mounted (fig. 5.9-1), wound core or stacked core technology distribution transformer ($\leq 2,500$ kVA, $U_m \leq 36$ kV)
 - Wound core or stacked core technology medium distribution transformer ($> 2,500 \leq 6,300$ kVA, $U_m \leq 36$ kV)
 - Large distribution transformer ($> 6.3 - 30.0$ MVA, $U_m \leq 72.5$ kV)
 - Voltage regulator (fig. 5.9-2)
- Special distribution transformers:
 - Special application: self-protected DT, regulating DT (OLTC), electronic regulate DT, low-emission DT or others (autotransformer, transformer for converters, double-tier, multiwinding transformer, earthing transformer)
 - Environmental focus: amorphous core DT with significant low no-load losses, DT with special low load-loss design, low-emission DT in regard of noise and/or electromagnetic field emissions, DT with natural or synthetic ester where higher fire-resistance and/or biodegradability is required
- Renewable distribution transformers:
 - Used in wind power stations, solar power plants or sea flow/generator power plants



Fig. 5.9-1: Pole mounted, Canada



Fig. 5.9-2: Liquid-immersed distribution transformer

5.9.2 Voltage Regulators

Siemens invented the voltage regulator in 1932 and pioneered its use in the United States. Voltage Regulators are tapped step autotransformers used to ensure that a desired level of voltage is maintained at all times. A voltage regulator comprises a tapped autotransformer and a tap changer. The standard voltage regulator provides $\pm 10\%$ adjustment in thirty-two 0.625 % steps. Voltage Regulators with $\pm 15\%$ and $\pm 20\%$ regulation are available for some designs.

Voltage regulators are liquid-immersed and can be 1-phase or 3-phase. They may be self-cooled or forced air-cooled. Available at 50 or 60 Hz and with 55 or 65 °C temperature rise, they can be used in any electrical system to improve voltage quality.

Voltage regulator ratings are based on the percent of regulation (i.e., 10 %). For example, a set of three 1-phase 333 kVA regulators would be used with a 10 MVA transformer (e.g., $10 \text{ MVA} \cdot 0.10/3 = 333 \text{ kVA}$). 1-phase voltage regulators are available in ratings ranging from 2.5 kV to 19.9 kV and from 38.1 kVA to 889 kVA (fig. 5.9-3). 3-phase voltage regulators are available at 13.2 kV or 34.5 kV and from 500 kVA to 4,000 kVA.

Voltage regulators can be partially or completely untanked for inspection and maintenance without disconnecting any internal electrical or mechanical connections. After the unit is untanked, it is possible to operate the voltage regulator mechanism and test the control panel from an external voltage source without any reconnections between the control and the regulator.

Standard external accessories

The standard accessories are as follows:

- External metal-oxide varistor (MOV) bypass arrester
- Cover-mounted terminal block with a removable gasketed cover. It allows easy potential transformer reconnections for operation at different voltages
- Oil sampling valve
- Two laser-etched nameplates
- External oil sight gauge that indicates oil level at 25 °C ambient air temperature and oil color
- External position indicator that shows the tap changer position
- Mounting bosses for the addition of lightning arresters to the source (S), load (L) and source-load (SL) bushings. They shall be fully welded around their circumference.

Accessories and options

Remote mounting kit

Extra-long control cable shall be provided for remote mounting of the control cabinet at the base of the pole.

Sub-bases

To raise the voltage regulator to meet safe operating clearances from the ground to the lowest live part.

Auxiliary PT

Operation at different voltages.

Testing

All voltage regulators shall be tested in accordance with the latest ANSI C57.15 standards.

Standard tests include:

- Resistance measurements of all windings
- Ratio tests on all tap locations
- Polarity test
- No-load loss at rated voltage and rated frequency
- Excitation current at rated voltage and rated frequency
- Impedance and load loss at rated current and rated frequency
- Applied potential
- Induced potential
- Insulation power factor test
- Impulse test
- Insulation resistance



Fig. 5.9-3: 1-phase voltage regulator, JFR

5.9.3 GEAFOLE Cast-Resin Transformers

GEAFOL transformers have been in successful service since 1965. Many licenses have been granted to major manufacturers throughout the world since then. Over 100,000 units have proven themselves in power distribution or converter operation all around the globe.

Advantages and applications

GEAFOL distribution and power transformers in ratings from 100 to approximately 50,000 kVA and lightning impulse (LI) values up to 250 kV are full substitutes for liquid-immersed transformers with comparable electrical and mechanical data. They are designed for indoor installation close to their point of use at the center of the major load consumers. The exclusive use of flame-retardant insulating materials frees these transformers from all restrictions that apply to oil-filled electrical equipment, such as the need for oil collecting pits, fire walls, fire extinguishing equipment. For outdoor use, specially designed sheet metal enclosures are available.

GEAFOL transformers are installed wherever oil-filled units cannot be used or where use of liquid-immersed transformers would require major constructive efforts such as inside buildings, in tunnels, on ships, cranes and offshore platforms, inside wind turbines, in groundwater catchment areas and in food processing plants. For outdoor use, specially designed sheet metal enclosures are available.

Often these transformers are combined with their primary and secondary switchgear and distribution boards into compact substations that are installed directly at their point of use.

When used as static converter transformers for variable speed drives, they can be installed together with the converters at the drive location. This reduces construction requirements, cable costs, transmission losses and installation costs.

GEAFOL transformers are fully LI-rated. Their noise levels are comparable to oil-filled transformers. Taking into account the indirect cost reductions just mentioned, they are also mostly

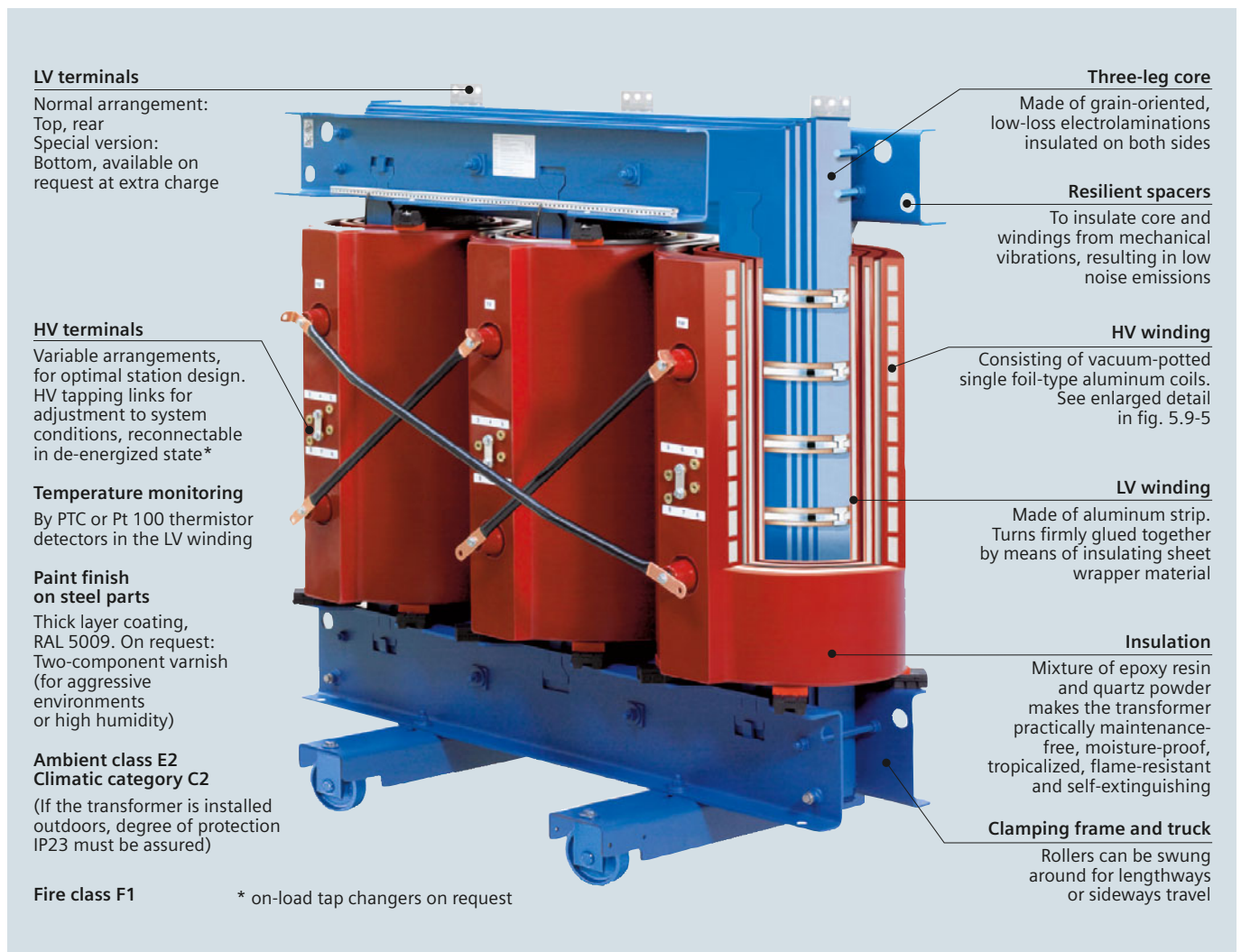

Fig. 5.9-4: GEAFOLE cast-resin dry-type transformer properties

Transformers

5.9 Distribution Transformers

cost-competitive. By virtue of their design, GEAFOLE transformers are practically maintenance-free.

Standards and regulations

GEAFOLE cast-resin dry-type transformers comply with IEC 60076-11, EN 60076-11 and EN 50541-1.

Characteristic properties (fig. 5.9-4)

HV winding

The high-voltage windings are wound from aluminum foil interleaved with high-grade insulating foils. The assembled and connected individual coils are placed in a heated mold and are potted in a vacuum furnace with a mixture of pure silica (quartz sand) and specially blended epoxy resins. The only connections to the outside are casted brass nuts that are internally bonded to the aluminum winding connections.

The external delta connections are made of insulated copper or aluminum connectors to guarantee an optimal installation design. The resulting high-voltage windings are fire-resistant, moisture-proof and corrosion-proof, and they show excellent aging properties under all operating conditions.

The foil windings combine a simple winding technique with a high degree of electrical safety. The insulation is subjected to less electrical stress than in other types of windings. In a conventional round-wire winding, the interturn voltages can add up to twice the interlayer voltage. In a foil winding, it never exceeds the voltage per turn, because a layer consists of only one winding turn. This results in high AC voltage and impulse voltage withstand capacity.

Aluminum is used because the thermal expansion coefficients of aluminum and cast resin are so similar that thermal stresses resulting from load changes are kept to a minimum (fig. 5.9-5).

LV winding

The standard low-voltage winding with its considerably reduced dielectric stresses is wound from single aluminum sheets with interleaved cast-resin impregnated fiberglass fabric (prepreg).

The assembled coils are then oven-cured to form uniformly bonded solid cylinders that are impervious to moisture. Through the single-sheet winding design, excellent dynamic stability under short-circuit conditions is achieved. Connections are submerged arc-welded to the aluminum sheets and are extended either as aluminum or copper bars to the secondary terminals.

Fire safety

GEAFOLE transformers use only flame-retardant and self-extinguishing materials in their construction. No additional substances, such as aluminum oxide trihydrate, which could negatively influence the mechanical stability of the cast-resin molding material, are used. Internal arcing from electrical faults and externally applied flames do not cause the transformers to

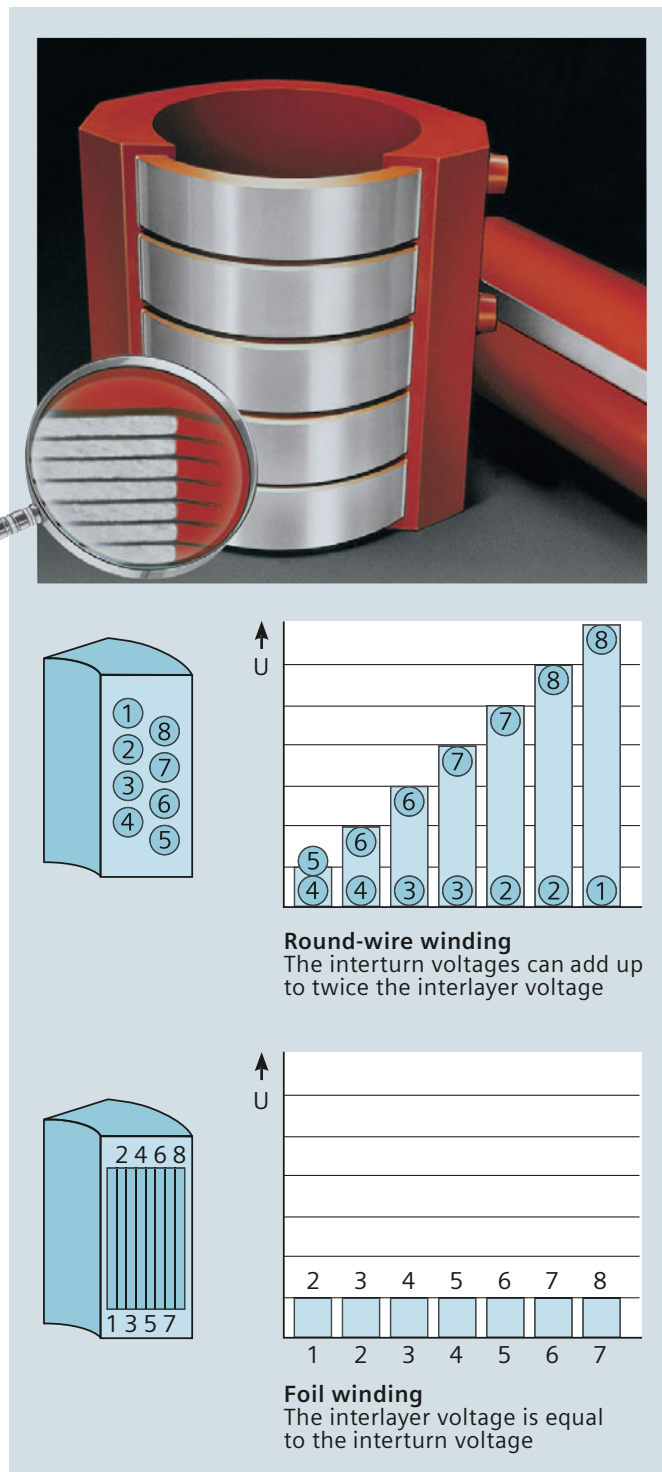

Fig. 5.9-5: High-voltage encapsulated winding design of GEAFOLE cast-resin transformer and voltage stress of a conventional round-wire winding (above) and the foil winding (below)

5

burst or burn. After the source of ignition is removed, the transformer is self-extinguishing. This design has been approved by fire officials in many countries for installation in populated buildings and other structures. The environmental safety of the combustion residues has been proven in many tests (fig. 5.9-6).

Categorization of cast-resin transformers

Dry-type transformers have to be classified under the categories listed below:

- Environmental category
- Climatic category
- Fire category

These categories have to be shown on the rating plate of each dry-type transformer.

The properties laid down in the standards for ratings within the category relating to environment (humidity), climate and fire behavior have to be demonstrated by means of tests.

These tests are described for the environmental category (code numbers E0, E1 and E2) and for the climatic category (code numbers C1 and C2) in IEC 60076-11. According to this standard, the tests are to be carried out on complete transformers. The tests of fire behavior (fire category code numbers F0 and F1) are limited to tests on a duplicate of a complete transformer that consists of a core leg, a low-voltage winding and a high-voltage winding.

GFAFOL cast-resin transformers meet the requirements of the highest defined protection classes:

- Environmental category E2 (optional for GFAFOL-BASIC)
- Climatic category C2
- Fire category F1

Insulation class and temperature rise

The high-voltage winding and the low-voltage winding utilize class F insulating materials with a mean temperature rise of 100 K (standard design).

Overload capability

GFAFOL transformers can be overloaded permanently up to 50 % (with a corresponding increase in impedance voltage and load losses) if additional radial cooling fans are installed (dimensions can increase by approximately 100 mm in length and width.) Short-time overloads are uncritical as long as the maximum winding temperatures are not exceeded for extended periods of time (depending on initial load and ambient air temperature).

Temperature monitoring

Each GFAFOL transformer is fitted with three temperature sensors installed in the LV winding, and a solid-state tripping device with relay output. The PTC thermistors used for sensing are selected for the applicable maximum hot-spot winding temperature.

Additional sets of sensors can be installed, e.g. for fan control purposes. Alternatively, Pt100 sensors are available. For oper-



Fig. 5.9-6: Flammability test of cast-resin transformer

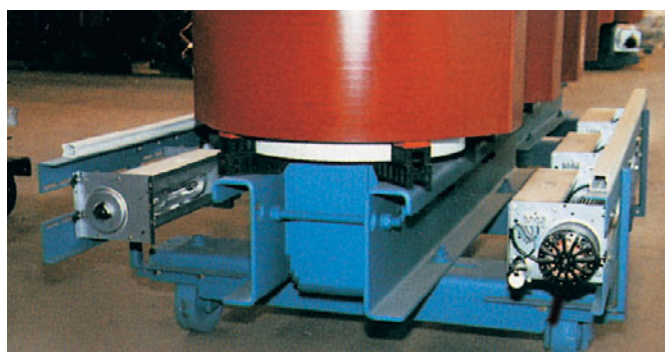

Fig. 5.9-7: Radial cooling fans on GFAFOL transformer for AF cooling

U_m (kV)	LI (kV)	AC (kV)
1.1	–	3
12	75	28
24	95*	50
36	145*	70

* other levels upon request

Table 5.9-1: Standard insulation levels of GFAFOL

ating voltages of the LV winding of 3.6 kV and higher, special temperature measuring equipment can be provided.

Auxiliary wiring is run in a protective conduit and terminated in a central LV terminal box (optional). Each wire and terminal is identified, and a wiring diagram is permanently attached to the inside cover of this terminal box.

Transformers

5.9 Distribution Transformers

Installation and enclosures

Indoor installation in electrical operating rooms or in various sheet metal enclosures is the preferred method of installation. The transformers need to be protected only against access to the terminals or the winding surfaces, against direct sunlight and against water. Unless sufficient ventilation is provided by the installation location or the enclosure, forced-air cooling must be specified or provided by others (fig. 5.9-7).

Instead of the standard open terminals, plug-type elbow connectors can be supplied for the high-voltage side with LI ratings up to 170 kV. Primary cables are usually fed to the transformer from trenches below but can also be connected from above (fig. 5.9-8).

Secondary connections can be made by multiple insulated cables, or by connecting bars from either below or above. Secondary terminals are made of aluminum (copper upon request).

A variety of indoor and outdoor enclosures in different protection classes are available for the transformers alone, or for indoor compact substations in conjunction with high-voltage and low-voltage switchgear panels. PEHLA-tested housings are also available (fig. 5.9-9).

Cost-effective recycling

The oldest of the GEAFOLE cast-resin transformers that entered production in the mid-1960s are approaching the end of their service life. Much experience has been gathered over the years with the processing of faulty or damaged coils from such transformers. The metal materials and resin used in GEAFOLE cast-resin transformers, that is, approximately 95 % of their total mass, can be recycled. The process used is non-polluting. Given the value of secondary raw materials, the procedure is often cost-effective, even with the small amounts currently being processed.

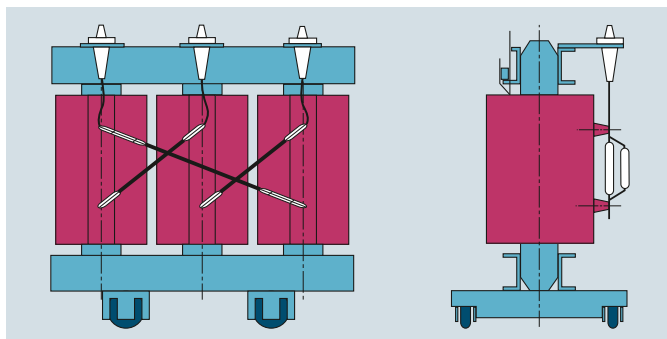

Fig. 5.9-8: GEAFOLE transformer with plug-type cable connections



Fig. 5.9-9: GEAFOLE transformer in protective housing to IP20/40

The GEAFOLE Basic – a true GEAFOLE and more

The GEAFOLE Basic is based on more than 45 years of proven GEAFOLE technology and quality, but it offers numerous innovations that has allowed Siemens to provide it with several very special characteristics. For example, the GEAFOLE Basic distribution transformer with a maximum rated power of 3.15 MVA and a maximum medium voltage of 36 kV is almost ten percent lighter than a comparable model from the proven GEAFOLE series. And this “slimming down” also positively affects the dimensions. This could be achieved by a considerably improved heat dissipation because of the new, patented design.

Of course all GEAFOLE Basic distribution transformers meet the specifications of IEC 60076-11, EN 60076-11 and EN 50541-1. They meet the highest requirements for safe installation in residential and work environments with Climatic Class C2, Environmental Class E2 (standard model meets E1; E2 is available as option at additional costs) and Fire Classification F1. With fewer horizontal surfaces, less dust is deposited, which leads to a further reduction in the already minimal time and effort needed for maintenance and also increases operational reliability.

Optimum compromise

The GEAFOLE Basic distribution transformer represents an optimum compromise between performance, safety and small dimensions. In addition, the high degree of standardization ensures the best possible cost-benefit ratio. Thanks to their compact shape and comprehensive safety certification, GEAFOLE Basic distribution transformers can be used in almost every environment.



A new design for your success –
the reliable, space-saving GEAFOLE Basic

1 Three-limb core

Made of grain-oriented, low-loss electric sheet steel that is insulated on both sides

2 Low-voltage winding

Made of aluminum strip; turns are permanently bonded with insulating sheet

3 High-voltage winding

Made of individual aluminum coils using foil technology and vacuum casting

4 Low-voltage connectors (facing up)

5 Lifting eyes

Integrated into the upper core frame for simple transport

6 Delta connection tubes with HV terminals

7 Clamping frame and truck

Convertible rollers for longitudinal and transverse travel (rollers optional)

8 Insulation made of an epoxy resin/ quartz powder mixture

Makes the transformer extensively maintenance-free, moisture-proof and suitable for the tropics, fire-resistant and self-extinguishing

9 High-voltage taps $\pm 2 \times 2.5 \%$

(on the high-voltage connector side) to adapt to the respective network conditions; reconnectable off load

Temperature monitoring

With PTC thermistor detector in limb V of the low-voltage winding (in all three phases upon request)

Painting of steel parts

High-build coating, RAL 5015: two-component coating upon request (for particularly aggressive environments)

Structure made of individual components

For example, windings can be individually assembled and replaced on site

5.9.4 GEAFOL Special Transformers

GEAFOL cast-resin transformers with oil-free on-load tap changers

The voltage-regulating cast-resin transformers connected on the load side of the medium-voltage power supply system feed the plant-side distribution transformers. The on-load tap changer controlled transformers used in these medium-voltage systems need to have appropriately high ratings.

Siemens offers suitable transformers in its GEAFOL design (fig. 5.9-10), which has proved successful over many years and is available in ratings of up to 50 MVA. The range of rated voltage extends to 36 kV, and the maximum impulse voltage is 200 kV (250 kV). The main applications of this type of transformer are in modern industrial plants, hospitals, office and apartment blocks and shopping centers.

Linking 1-pole tap changer modules together by means of insulating shafts produces a 3-pole on-load tap changer for regulating the output voltage of 3-phase GEAFOL transformers. In its nine operating positions, this type of tap changer has a rated current of 500 A and a rated voltage of 900 V per step. This allows voltage fluctuations of up to 7,200 V to be kept

under control. However, the maximum control range utilizes only 20 % of the rated voltage.

Transformers for static converters

These are special liquid-immersed or cast-resin power transformers that are designed for the special demands of thyristor converter or diode rectifier operation.

The effects of such conversion equipment on transformers and additional construction requirements are as follows:

- Increased load by harmonic currents
- Balancing of phase currents in multiple winding systems (e.g., 12-pulse systems)
- Overload capability
- Types for 12-pulse systems, if required

Siemens supplies oil-filled converter transformers of all ratings and configurations known today, and dry-type cast-resin converter transformers up to 50 MVA and 250 kV LI (fig. 5.9-11).

To define and quote for such transformers, it is necessary to know considerable details on the converter to be supplied and



Fig. 5.9-10: 16/22-MVA GEAFOL cast-resin transformer with oil-free on-load tap changer

on the existing harmonics. These transformers are almost exclusively inquired together with the respective drive or rectifier system and are always custom-engineered for the given application.

Neutral earthing transformers

When a neutral earthing reactor or earth-fault neutralizer is required in a 3-phase system and no suitable neutral is available, a neutral earthing must be provided by using a neutral earthing transformer.

Neutral earthing transformers are available for continuous operation or short-time operation. The zero impedance is normally low. The standard vector groups are zigzag or wye/delta. Some other vector groups are also possible.

Neutral earthing transformers can be built by Siemens in all common power ratings in liquid-immersed design and in cast-resin design.



Fig. 5.9-11: 23-MVA GEAFOLE cast resin transformer 10 kV/Dd0Dy11

Transformers for Silicon-reactor power feeding

These special transformers are an important component in plants for producing polycrystalline silicon, which is needed particularly by the solar industry for the manufacture of collectors.

What's special about these transformers is that they have to provide five or more secondary voltages for the voltage supply of the special thyristor controllers. The load is highly unbalanced and is subject to harmonics that are generated by the converters. Special geafol cast resin transformers with open secondary circuit have been developed for this purpose. The rated power can be up to round about 10 MVA, and the current can exceed an intensity of 5,000 amps depending on the reactor type and operating mode. Depending on the reactor control system two-winding or multi-winding transformers will be used (fig. 5.9-12).



Fig. 5.9-12: 4771 kVA GEAFOLE converter transformer with 5 secondary windings 10/0.33 – 2.4 kV

For further information:

Fax: ++49 (0) 70 21-5 08-495
www.siemens.com/energy/transformers

5.10 Traction Transformers

Siemens produces transformers for railway applications called traction transformers. These transformers are installed in electric cars such as high-speed trains, electric multiple units (EMUs) and electric locomotives. Their main purpose is transform the overhead contact line voltage, which range mainly from 15 kV up to 25 kV, to voltages suitable for traction converters (between 0.7 kV and 1.5 kV) (fig. 5.10-1).

Siemens develops and produces traction transformers for rolling stock applications of all relevant ratings, voltage levels and customer-specific requirements.

All products are optimized with regard to individual customer requirements such as:

- Frequency, rating and voltage
- Required dimensions and weights
- Losses and impedance voltage characteristics
- Operational cycles and frequency response behavior
- Environmental requirements

Characterization

Technically, traction transformers are in general characterized as follows:

- 1-phase transformers
- Ratings up to 10 MVA and above
- Operating frequencies from 16 $\frac{2}{3}$ to 60 Hz
- Voltages: 1.5 kV DC, 3 kV DC, 15 kV, 25 kV, 11.5 kV or other specific solutions
- Weight: < 15 t
- Auxiliary windings and/or heater windings according to customer specification
- Single or multiple system operation
- Under floor, machine room or roof assembly
- Traction windings to be used as line filters



Fig. 5.10-1: Traction transformer for high speed trains

- Integrated absorption circuit reactors
- Various cooling media for all ratings: mineral oil, silicone or ester fluid for highest environmental compatibility

In case of customer request:

- With cooling plant – integrated in one frame together with the transformer or stand-alone solution
- Nomex insulation for highest energy density

Examples

The examples shown in the table are typical applications where traction transformers from Siemens were used (table 5.10-1).

High speed train AVE S102 for RENFE Spain	Electric locomotive for ÖBB Austria (1216 Series) for cross-european haulage	World's most powerful series-production freight locomotive for China
Operation: Madrid – Barcelona Travel time: 2 h 30 min for 635 km Number of cars: 8 Power system: 25 kV/50 Hz Maximum power at wheel: 8,800 kW Max. speed: 350 km/h Number of seats: 404	4 system operation AC 15 kV: 16 $\frac{2}{3}$ Hz AC 25 kV 50 Hz DC 3 kV DC 1.5 kV Speed: 200 – 230 km/h Weight 87 t	6 axle machine 9,600 kW on 6 axles hauling of 20,000 t trains

Table 5.10-1: Siemens develops and produces traction transformers for rolling stock applications of all relevant ratings and voltage levels

5.11 Transformer Lifecycle Management

Introduction

Power transformers usually perform their work, humming quietly for decades, without any interruption. Operators have thus come to rely on their solid transformer capacity, often performing only minimal maintenance using traditional techniques (fig. 5.11-1).

Today, load requirements, additional environmental constraints and recent corporate sustainability objectives to keep a close eye on the operational value of the equipment, have led Siemens to provide a comprehensive set of solutions to keep the equipment at peak level under any operational circumstances. A new generation of asset managers is interested in the “operational” value, including the replacement cost, instead of the depreciated book-value over decades, which is often close to zero.

Power transformers are long-lasting capital investment goods. Purchasing and replacement require long periods of planning engineering and procurement. Each individual conception is specially adapted to the specific requirements. The corresponding high replacement value, and the important lead time are in the focus.

What is TLM™?

Siemens Transformer Lifecycle Management™ (TLM™) includes highly experienced transformer experts who provide the most effective lifecycle solutions for power transformers of any age and any brand.

Maintaining customers’ power transformers at peak operating level is the prime objective of the Siemens TLM set of solutions. Siemens TLM is based on the expertise available in all Siemens transformer factories, which are well-known for high quality and low failure rates. The TLM scope of services is explained in the following briefly:

Condition Assessment & Diagnostics (fig. 5.11-2)

- Level 1: SITRAM® DIAG ESSENTIAL
- Level 2: SITRAM® DIAG ADVANCED
- Level 3: SITRAM® DIAG HIGH VOLTAGE TESTING

The SITRAM® DIAG program consists of three layers and provides diagnostic modules for individual transformer and for the assessment of complete installed fleets and transformer populations.

SITRAM® DIAG ESSENTIAL (Level 1)

All modules in the diagnosis Level 1 “ESSENTIAL” are to be applied on energized transformers. The most powerful toolbox for this application is the diagnosis of the insulating liquid. Additional stand alone modules are available to be applied when the oil tests and/or the operating personnel gave indication for deficiencies or changes.

- Standard oil test (8 –12 parameters)



Fig. 5.11-1: Siemens Transformer Lifecycle Management™ scope of services

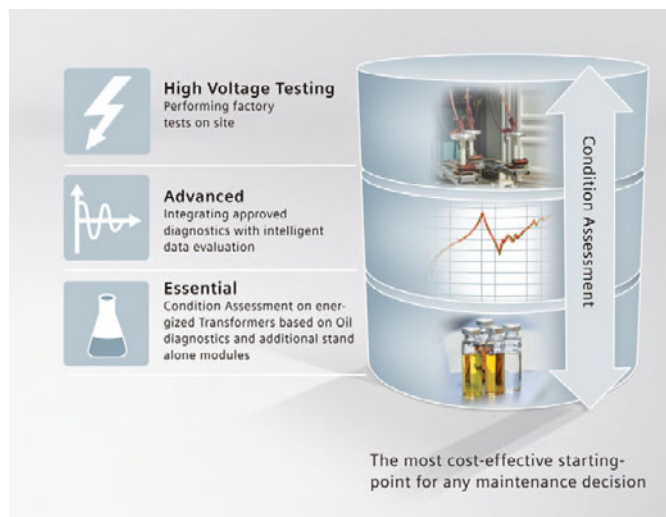

Fig. 5.11-2: SITRAM® DIAG provides diagnostic modules for individual transformers and for the assessment of complete fleets

- Dissolved Gas in Oil Analysis (DGA)
- Furanic components
- Moisture

Transformers

5.11 Transformer Lifecycle Management

Additional stand alone modules

- PD (UHF-, acoustic sensors, corona camera)
- Noise measurement
- Vibration measurement
- Thermograph scans

SITRAM® DIAG ADVANCED (Level 2)

The extended modules are applied on de-energized and disconnected transformers. Most measurements repeat the measurements as shown in the manufacturers test report and by comparing the results any differences will be highlighted. Level 2 provide information about the insulation (dielectric) condition as well as the mechanical condition (displacements) of the active part of a transformer.

- Ratio and phase angle
- Winding resistance
- C-tan delta (windings and bushings)
- Insulation resistance and
- Polarization Index (PI)
- Impedance
- No load current and losses
- At low voltage
- FDS/PDC
- FRA

Additional all modules of Level 1 apply

SITRAM® DIAG HIGH VOLTAGE TESTING (Level 3)

High-Voltage-Tests on-site is usually required following on-site repairs, factory repairs, refurbishment or relocation and also performed to assure the results from the level 1 and level 2 assessments. The SITRAM DIAG mobile test fields provides solutions for all kind of HV testing and loss measurement. Heat runs or long duration tests are feasible depending on size and voltage level of the transformer under test. Level 3 assessment can be combined with all modules out of level 1 and level 2.

- Load losses
- No load losses and currents
- Applied overvoltage tests
- Induced overvoltage tests
- Partial discharge testing
- DC testing
- Heat runs
- Long duration tests

Additional all modules of Level 1 and 2 apply

Online Monitoring (fig. 5.11-3)

- SITRAM® GUARDS
- SITRAM® CM
- SITRAM® iCMS

The new Siemens third-generation SITRAM® MONITORING range is providing compatible, modular and customized solutions for individual power transformers (new and retrofit) and solutions for entire transformer fleets.

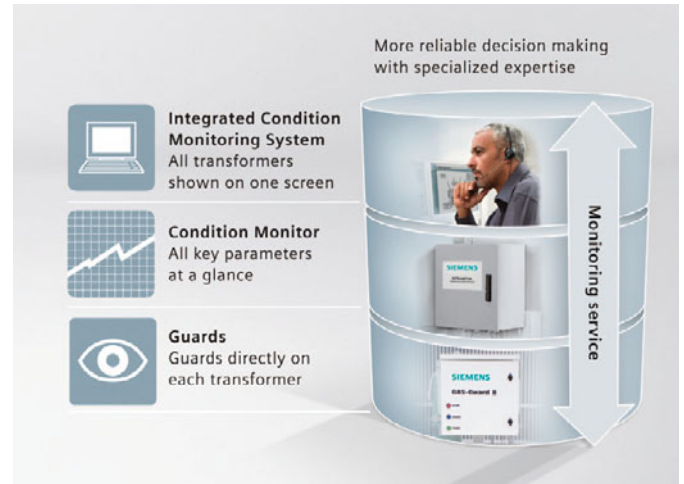

Fig. 5.11-3: All levels of the SITRAM® MONITORING concept

In general, these systems allow a continuous monitoring of power transformers, which are going far beyond the traditional method of taking offline measurements. The experience demonstrates clearly, that with Online monitoring, an improved efficiency in the early detection of faults can be achieved. So that curative and corrective maintenance actions can be planned and scheduled well in advanced. It is also possible to use spare capacities up to the limits. This is resulting in a higher reliability, efficiency and longer service life of power transformers.

SITRAM Guard's:

Standardized and approved sensor technologies as a single solution for individual transformers.

- GAS Guard (online gas-in-oil analysis)
- PD-Guard (partial discharge monitoring)
- BUSHING Guard (bushing monitoring)
- TAPGUARD® (on-load tap changer monitoring)

SITRAM Condition Monitor (SITRAM CM):

The SITRAM Condition Monitor is a modular and customized system, which integrates information from single sensors and SITRAM Guard's for each transformer individually and is able to provide condition information about all key components. A local data storage module and a communication interface enable the user to access the information remotely.

SITRAM integrated Condition Monitoring System (SITRAM iCMS):

This "Knowledge Module" solution is monitoring all transformers in transmission and distribution substations, power generation plants or in large industries to an existing or next generation protection and control system. Furthermore is it able to integrate the recorded data of a complete transformer fleet of a utility to a superordinated system. It is based on the modular hardware architecture of the SITRAM CM.

In addition to the monitoring hardware and software, Siemens TLM transformer experts are available for remote nursing solutions for questionable transformers, analyzing and interpretation of recorded monitoring data.

Consulting Expertise and Training

- Engineering service
- Advice & recommendations
- Educational seminars
- Custom-tailored workshops

The Siemens TLM set of solutions integrates a wide range of services that are designed to considerably extend the life of the operator's transformers. Siemens's preferred approach is to integrate all transformers – of any age and any brand – in the plan that is prepared for customers so that they can make the best decision about replacement/extension and any related matters. Siemens TLM also offers a series of standardized customer trainings. These programs are specifically designed to broaden customer awareness of the various concept and design options. Lifecycle management is, of course, an integral part of the training.

Maintenance & Lifecycle Extension

- Preventive & corrective maintenance
- On site active part drying & de-gassing
- Oil regeneration
- Life extension products
- End of life management

We'll get your transformers back in top form – and without service interruptions. Our TLM™ products for extending service life minimizes the unavoidable, undetectable and ongoing aging process that is taking place inside transformers. This internationally-recognized technologies for life extension are rounded up by a cooling efficiency retrofit solution.

SITRAM DRY (fig. 5.11-4)

The SITRAM® DRY is an advanced technology for preventive and continuous online transformer drying. The system removes moisture from the insulation oil through disturbing the moisture equilibrium so that moisture diffuses from the wet insulation paper to the dried insulation oil. This process will removing the moisture in a gentle and smooth way from the solid insulation and will increase the dielectric strength of the insulating oil.

- Continuous online removal of moisture from solid insulation and oil
- Based on a molecular sieve technology
- Easy to install on any transformer in operation
- Temperature and moisture monitoring
- Cartridge replacement and regeneration service
- Cabinet Version (NEMA4)
- New: SITRAM® DRY Smart, mobile solution for distribution transformers very soon available

Experience the functions of SITRAM® DRY in sound and vision:
www.siemens.de/energy/sitram-dry-video

SITRAM REG

Siemens developed the SITRAM® REG technology to clean contaminated oil and restore its dielectric properties. SITRAM® REG is a modified reclamation process based on the IEC 60422 standard. Oil is circulated continuously through regeneration columns.



Fig. 5.11-4: Cabinet version of the SITRAM DRY equipped with a control module

- An oil change is not required
- Improves the quality of insulating oil to that of new oil
- Prolongation of the lifetime and increased reliability of old transformers
- Preventive action against the progressive insulation ageing process
- Sustainable improvement in the condition of the insulation
- Suitable for all power transformers
- Economically independent of the current price of new oil
- No service interruptions
- Great and long-lasting cleaning effect

SITRAM COOL

SITRAM COOL is an add-on retrofit solution and consists of hardware and software for the automatic, optimized control of transformer cooling system:

- Increase of the total efficiency of the transformer
- Reduction of auxiliary losses
- Reduction of noise level
- Reduction of maintenance
- If required and if applicable → upgrading

Spare Parts & Accessories

The supply of spare parts is another strong point of Siemens TLM. Upon request, Siemens may advise customers on what

Transformers

5.11 Transformer Lifecycle Management

accessories will best fit their needs. Examples include Buchholz relays of various sizes, temperature sensors, oil flow alarms and oil level indicators. In order to provide the best solution, Siemens TLM will verify alternative products and strive to make technical improvements using state-of-the-art technologies, particularly important when original spare parts are not longer available.

Spare parts from Siemens TLM™ offers you (fig. 5.11-5):

- Stringent quality assurance standards to ensure that spare parts are manufactured in accordance with the Siemens OEM specifications
- Continuous improvement of technology and materials
- Outage planning and support based on customized spare parts programs
- Spar part service for all transformers in the Siemens family (SIEMENS, TU, VA TECH, Ferranti-Packard, PEEPLES)

Repair & Retrofit

Can we make your old transformer as good as new? We can come very close and usually improve your old transformers with Siemens new state-of-the-art technologies. One highlight of TLM™ is the repair, overhaul, and modernization of your power transformers. Repairs are performed in one of our dedicated repair shops around the world, but are also done on-site when our mobile workshops come to your facility. In addition, we can retrofit or modernize transformers in various ways.

Whether your transformer has failed or you're planning timely corrective maintenance our TLM™ team of experts is available for short-term repairs.

With its dedicated repair facilities at our technology center in Nuremberg, Germany, and elsewhere around the world, Siemens has created a professional setting to get your transformers back into shape. Even the largest and heaviest transformers in the world can be easily moved, inspected, and repaired.

The repair facilities handle all problems that arise over the lifecycle of a transformer, including installation of new on-load tap changers and tapping switches, increasing performance, as well as completely replacement of windings. In addition, all components can be reconditioned and retrofitted with the latest materials as needed. For everything from design to the latest modern winding techniques to final inspection and testing, the manufacturing processes at our renowned transformer plants are continuously being improved. These improvements support the maintenance and repair of your transformers (fig. 5.11-6).

Transport, Installation & Commissioning

Siemens technical experts and engineers whom work on projects that include installing new transformers or changing the locations of old transformers, have decades of experience. They are expert at disassembly and preparation for transport, storing and handling of delicate components. Assembly is the daily work of these Siemens experts, and Siemens offers its exhaustive experience for complete solutions for customers so that their equipment value remains at its peak for a long time.

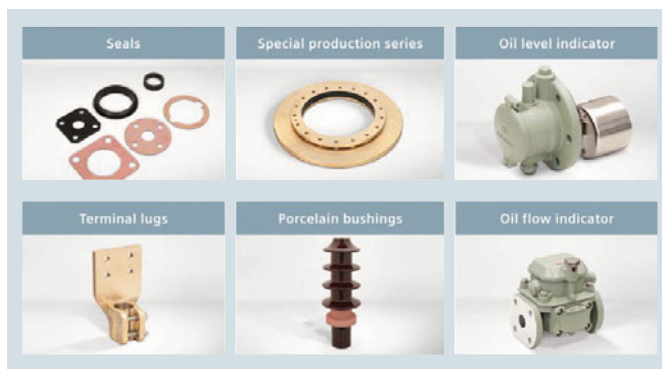

Fig. 5.11-5: Maximize the availability of every transformer with the TLM™ spare part program



Fig. 5.11-6: Repair shop in Nuremberg, Germany

For further information, please contact your local Siemens sales representative or contact:

Phone: +49 (180) 524 7000
Fax: +49 (180) 524 2471
E-mail: tlm@siemens.com
www.siemens.com/energy/TLM

